



# Index

## Company profile

<i>Company profile</i> _____	2-8
------------------------------	-----

## Air filter

<i>Urethane air filter / Mini collection</i> _____	9-15
<i>Air filter</i> _____	16-21
<i>Carburetor air filter</i> _____	20
<i>Carbon fiber light-weight filter</i> _____	22

## Intake system

<i>Carbon fiber light-weight filter &amp; kits</i> _____	23
<i>Project golf / super inlet big tube</i> _____	24-25
<i>New cold air intake system</i> _____	26
<i>Aero form</i> _____	27
<i>Carbon charger intake system-----Top Speed</i> _____	28-31
<i>Carbon fiber intake system-----SHARK</i> _____	32-33
<i>Carbon fiber aero form intake system</i> _____	34-37
<i>Standard air intake system</i> _____	38-39
<i>Cold air intake system</i> _____	40
<i>Anti-vibration kits</i> _____	41
<i>Ford musang &amp; Chevrolet corvette</i> _____	42
<i>Muscle power truck &amp; suv kits</i> _____	43
<i>Truck kits</i> _____	44-45
<i>Hexagon mushroom air filter intake system</i> _____	46

## Accessories

<i>Performance oil filter</i> _____	47-48
<i>Super spiral turbo ventilator</i> _____	49
<i>Silicone coupler</i> _____	50
<i>Coupler &amp; reducer &amp; anti-vibration rubber</i> _____	51
<i>Adaptor</i> _____	52
<i>Racing kits</i> _____	53-56

## Stock replacement air filter

<i>Stock replacement air filter</i> _____	57-80
---	-------



# PROFILE

# MILESTONE

COMPANY

## One passionate man? 100% confidence.

Founded by one passionate engineer in 1991, Simota racing sports has developed a dedicated staff with the extensive knowledge base and solid skills acquired by training and experience. Over the years, Simota has introduced several industry-leading products, which were later followed by even other famous brand. This is why we have 100% confidence in providing innovative, state-of-the-art air intake systems and complete service for our customers.

## Engineered to breathe like never before

Our R&D team is very professional and experienced for design and developing the air intake systems and stock replacement air filters. With continuous technical innovation, we have introduced many innovative products to the market. We have also extended our product line into other auto accessories as well.

## Patents & Copy right

We pursue patent protection for our innovations. Along with the customer satisfaction, Simota is committed to provide the best products and services to meet customers' need.

## Established since 1991

- 1999- The mass production of cold air intake system, Carbon fiber intake system, air filters.
- 2001-Sport Truck kits were approved by well-known customers in the world and start to mass production.
- 2002- Aero intake system was released and mass production.
- 2004-The production of process of Urethane filter got the patent and mass production.
- 2005-Simota was certified TUV.ISO 9001
- 2006-The air filter, foam filter and oil filter of Motorcycle released.
- 2008-Launching of Maha LPS3000 four-wheel chassis dynamometer
- 2009-Shark carbon air intake with patent was released, Universal air intake DRAGON and Air Storm series mass production.

## Company Sketch

- Factory Area: 71,167 square feet
- Annual Sales Revenue: USD 7 million
- Capacity: 600,000 sets / year
- Employees: 100
- R&D Staff: 10

## Sales Markets Breakdown

- America
- Europe
- Asia
- South America
- Oceania



COMPANY





COMPANY

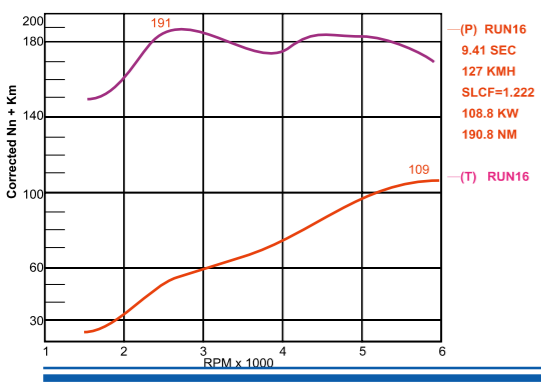

**SIMOTA CONE FILTER**  
**TORQUE: 191Nm**  
**POWER: 109KW**  
**ESTIMATED PRICE: R25**  
 The same filter as Anthony's original one but without the optional heat shield. It was cleaner than Anthony's and was tested long after his one. The good thing is that it got exactly the same readings which goes to show that things were being done right.  
**Top power and top torque for bargain price.**

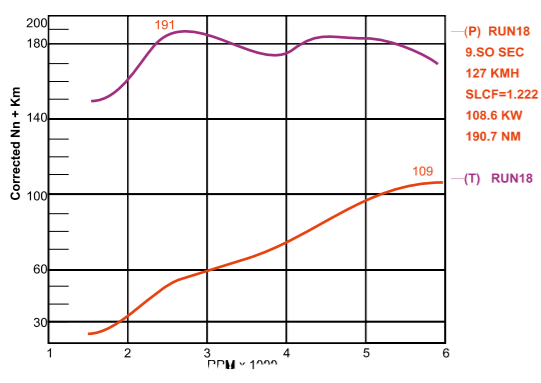

**ANTHONY'S ORIGINAL SIMOTA FILTER**  
**TORQUE: 191Nm**  
**POWER: 109KW**  
**ESTIMATED PRICE: R250**  
 Anthony had a normal Simota filter with the extra heatshield fitted to the car. The filter sounds damn nice and looks good with the extras.



SOURCE: SPEED & SOUND MAGAZINE, ISSUE 29 / www.speedandsound.co.za

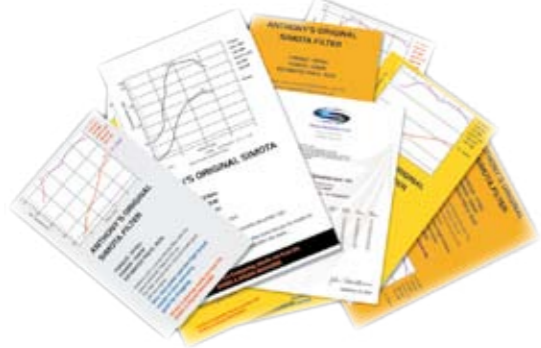

Tests performed on the same base Tiburon. Filters were of the same size and were intended by their respective manufacturers for the same application. Manufacturers including BMC, PPR, K&N, Autostyle, Pipercross, Simota and others. **Guess what? Simota is ranked as No. 1!**

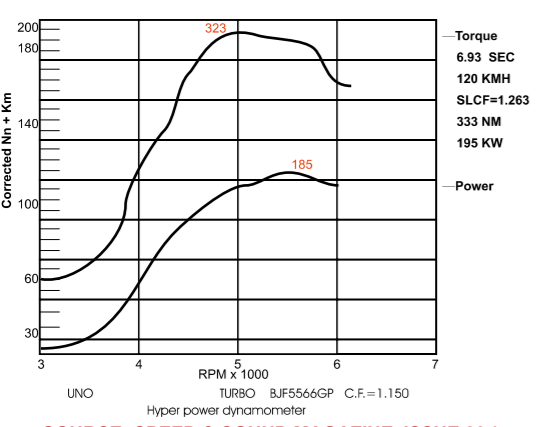

**JEDI'S ORIGINAL SIMOTA**  
**TORQUE: 323Nm**  
**POWER: 185KW**  
**Peak @ 6.93 sec**  
**ESTIMATED PRICE: N/A**  
 Jed's filter of choice. Decent torque but the kilowatts are pretty high. Nice smooth curves too.  
**This is a good budget filter that does the job it's made for.**  
 Maybe he'll change his mind after the tests...



SOURCE: SPEED & SOUND MAGAZINE, ISSUE 30 / www.speedandsound.co.za

Test on Fiat Uno Turbo at Jedi Motorsport, 75 Hay Street, Rosettenville, S.A.



**URETHANE FILTER SOME AIR IS GOOD, MORE AIR IS BETTER**

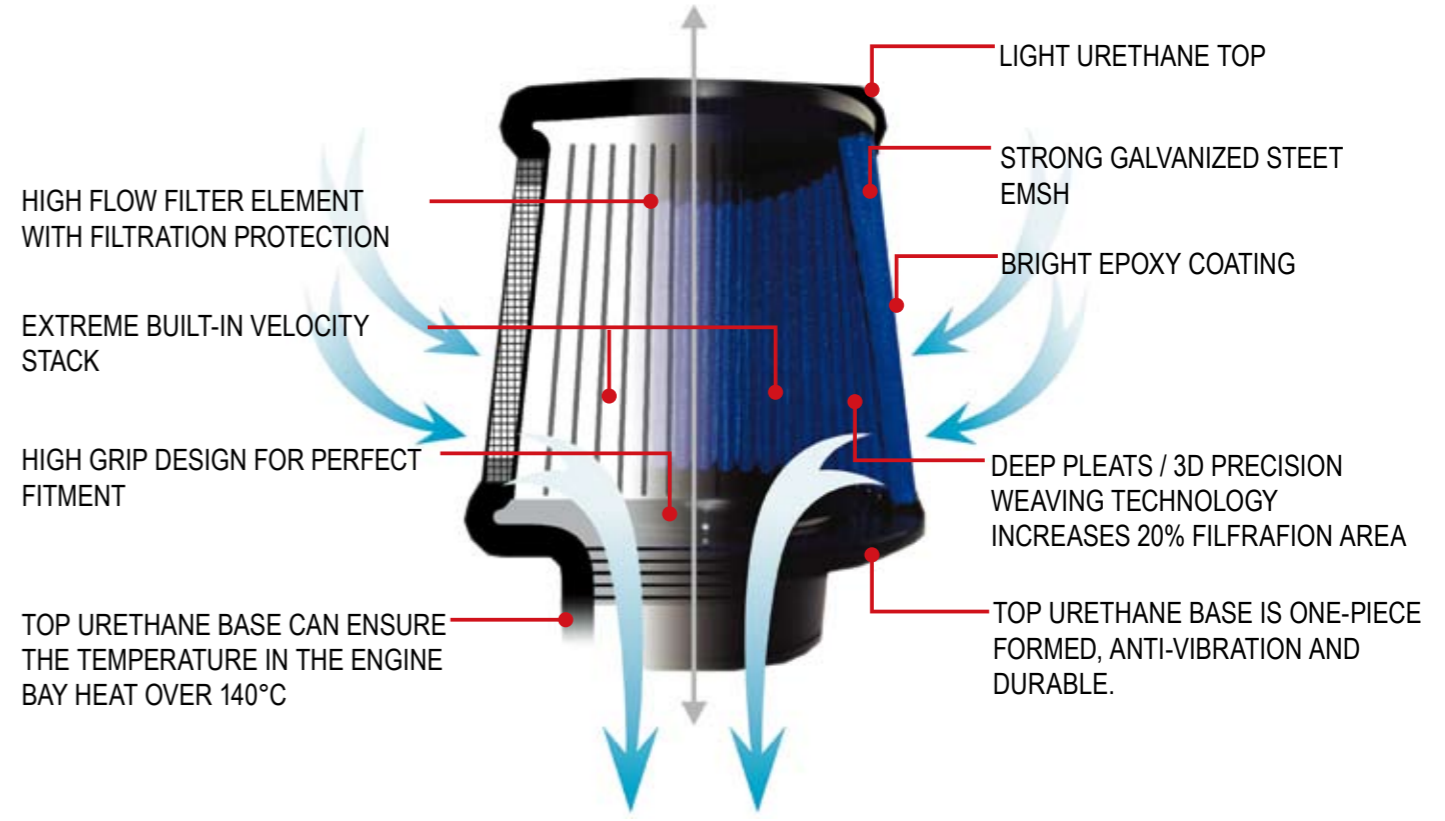

**U.S.A. CDI TEST REPORT**

**Simota Racing Sports Inc.**  
 www.simota.com  
 info@simota.com

Following is pretty easy.....  
 Leading however, demands so much more...  
 Simota is proud to introduce the true performance filter elements.  
 "Tried and true" The Simota High Flow Filter features test-proven, maximum air flow rate with superior filtration protection. K&N used to be the leader in the industry, but if you still think so, think again!

**Caldwell Development, Inc.**  
 1273 Activity Drive  
 Vista, CA 92083  
 Phone: (760)599-8020 Fax: (760)599-8022

Inches of Water	Simota WS-001	K&N RC3870	AEM 60-90201
1	178	159	153
2	232	217	207
3	285	265	253
4	323	302	293
5	365	336	326
6	393	369	357
7	427	400	386
8	456	427	412
9	484	451	437
10	510	477	459
11	533	499	482
12	559	519	504

*John Caldwell, president*  
 September 25, 2003

Test Note: Testing performed on a computerized precision flow bench by Caldwell Development Inc., based in Vista, California, USA. (http://www.caldwelldevelopment.com) All filter elements were flow tested at the same H2O restriction by using the square law formula. All filter elements tested were of equal size and were intended by their respective manufacturer for the same application.

**FACT: Simota outflows K&N and AEM.**

COMPANY





# TRADITIONAL VS SIMOTA URETHANE FILTER

**This is an air filter,**  
Traditional air filter 590gm  
\*Trimming down by 39%!



**and this is THE AIR FILTER!**  
SIMOTA urethane air filter 360gm

**Trimming down by 39%!**

## Comparison Between Traditional Air filter & SIMOTA Urethane Air Filter

	Traditional Air Filter	SIMOTA urethane air filter
<b>Warranty</b>	• NO one can	• Million miles warranty!
<b>Weight</b>	• Heavy	• Extremely lightweight
<b>Appearance</b>	• Soft aluminum mesh deforms easily • Old style	• Strong galvanized steel mesh coated with Epoxy • Bright, dashing look • Anti-Rust
<b>Condition</b>	• Not good for use in bad condition (very cold / hot) or vibration environment • The filter body is easy to be separated from the bas	• It is impossible for the filter body to fall off from the filter base under all circumstances

# AIR FILTERS COMPARISON TABLE

## DURABILITY COUNTS

CONDITION: In summertime, the actual temperature in the engine bay could surge up to almost 302°F (almost approx. 150°C). If you drive a long, long upward road, that is closely the same situation.

TESTING PROCEDURE: We test the durability of 2 Simota urethane filters along with the other five filters competitors.

Our staff put all these filters into an oven to see if these filters can endure extreme heat.

RESTLT: Only Simota passes through with flying colors. You can see the right chart and the fact is: Simota heads the list.

What if your filter simply melts down under heat like other big names? That's where durability counts.....



Simota URETHANE Filter is your best choice.

## See the real stuff that lasts longer

Duration & Temperature in Oven	Rubber base filter	G brand	J brand	K brand	Abrond	Simota
1 hour at 100°C(212°F)	X out	survied	survied	survied	survied	survied!
1 hour at 120°C(248°F)	X out	 The structure melts	 The base melts, the cap falls off	The base deforms	survied	survied!
1 hour at 130°C(266°F)	X out	X out	X out	 The base melts	 The base melts	survied!
1 hour at 140°C(284°F)	X out	X out	X out	X out	X out	survied!





COMPANY

Comparison, between SIMOTA's Urethane Air filter & "K" Brand Filter



SIMOTA's Urethane Air filter

"K" Brand Filter



ONE-PIECE FORMED

INFRINGEMENT OF GLLUE

Brand	SIMOTA's Urethane Air Filter	"K" Brand Air filter
Category		
Cap and Base Construction	Strong galvanized steel mesh with bright epoxy coating simply demonstrates functional beauty!	Soft aluminium mesh not only suffers form erosion, but also deforms easily when applied to turbo / high revving engines.
Quality Control	For ordinary & profesoral purpose	Regular Spill-over rubber compound decreases filtration surface as much as 20%.
Raw Materials & Compound	The optimized formula for SIMOTA's urethane construction ensures perfect airtightness with the intake pipe.	Easily air loose
Price	Competitive priece	High

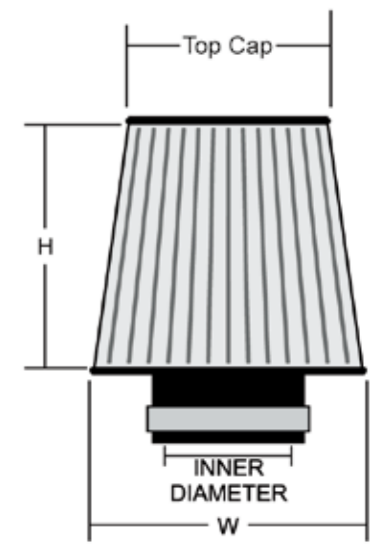

TABLE 1 : Inner Diameter and Width

Neck	Width of Base	Code
60mm	151	A02
65mm	151	B02
70mm	151	C02
77mm	151	D02
80mm	151	E02
84mm	151	F02
89mm	151	G02
101mm	151	H02
114mm	151	I 02
60mm	120	A12
65mm	120	B12
70mm	120	C12
77mm	120	D12
80mm	140	E01
84mm	140	F01
89mm	140	G01
80mm	146	E08(slant)
84mm	146	F08(slant)
89mm	146	G08(slant)
127mm	165	J 03
114mm	170	I 04
152mm	190	K05
65mm	100	B06
25mm	50	L13
20mm	50	M14
18mm	50	N15
15mm	50	O16
12mm	50	P17
9mm	50	Q18
45mm	72	R19
101mm	190	H09
101mm	190 (elliptical base)	H10
89mm	125	G20
60mm	130	A21

TABLE 2 : Style

Style	Code
red filter element with red epoxy	1
blue filter element with blue epoxy	2
red filter element w/o epoxy	3
blue filter element w/o epoxy	4
stainless steel element	5
white filter element w/o epoxy	6
stainless steel (200*200 mesh) with red epoxy	7
stainless steel (200*200 mesh) with blue epoxy	8
red filter element with red epoxy (slant)	9
blue filter element with red epoxy (slant)	10
red filter element w/o epoxy (slant)	11
blue filter element w/o epoxy (slant)	12
stainless steel (200*200 mesh) with red epoxy(slant)	13
stainless steel (200*200 mesh) with blue epoxy(slant)	14
Sponge filter element w/o epoxy (rhombus)	15
blue cotton element with painting iron net	16
pink cotton element with painting iron net	17
blue filter element with blue epoxy (15mm depth)	18

Example:

If you would find out the filter which has Neck 77mm, Width 151mm, Height 130mm with blue filter element with blue epoxy, x the exact item number is JAU-D02201-05

**JAU-D02**   **2**   **01** - **05**  
 Inner Ø   Style   Top Cap   Height

TABLE 3 : Top Cap

Top cap	Code
flat urethane cap 125mm	01
double cone metal cap 120mm	02
double cone metal cap 190mm	03
coupe shaped metal cap	04
WS248 styled cap	05
WS249 styled cap	06
flat metal cap 120mm	07
flat metal cap 89mm	08
double cone metal cap 89mm	09
KTR-61 exclusive cap	10
KTR-59 exclusive cap	11
KTR-55 exclusive cap	12
flat metal cap(120mm)with a hole dia.8.2mm)	14
bell shaped plastic cap	15
flat metal cap(120mm)with a hole dia.25.5mm)	16
truck fillet metal cap 120mm	18
BB-253/254 exclusive stainless steel cap	19
mini breater cap 50mm	23
mini breater cap 50mm(with heat shield)	24
PK01 flat metal cap	29
mini breather flat cap 50mm with a hole M6 and a unt M5	30
AC flat plastic cap	31
mini breather flat cap 55mm with a M6 hole and a M5 nut	37
flat mini breather cap 55mm	38
flat mini breather cap 50mm	42
mini breather flat cap 50mm with a M6 hole and a M5 nut	43
urethane cap 100mm	44
urethane cap 80mm	45
coupe shaped plastic cap	46
metal cap 64mm	47
metal cap 74mm	48
K-TYPE mini breather cap 50mm	51
89 double inlet mentel cap(inner hole 36mm)	55
120 double inlet mentel cap(inner hole 70mm)	56
148 flat metal cap	57
urethane cap 125mm(w/o logo)	61
120 double inlet metal cap (w/o logo)	62
PK01 mental cap (w/o logo)	65
89 double inlet metal cap(inner hole 36mm)(w/o logo)	67
120 double inlet metal cap(inner hole 70mm)(w/o logo)	68
89 double inlet metal cap(w/o logo)	69

TABLE 4 : Height

Height	Code
90mm	01
100mm	02
110mm	03
120mm	04
130mm	05
140mm	06
145mm	07
150mm	08
160mm	09
170mm	10
180mm	11
190mm	12
200mm	13
210mm	14
220mm	15
230mm	16
240mm	17
125mm	18
remarks:only for stainless steel	
70mm	19
65mm	20
35mm	21
remarks:only for breather filter	
48mm	22
50mm	23
60mm	24
80mm	25
75mm	26
165mm	27

AIR FILTER



## NOW-WOVEN FABRIC (EPOXY RESIN)

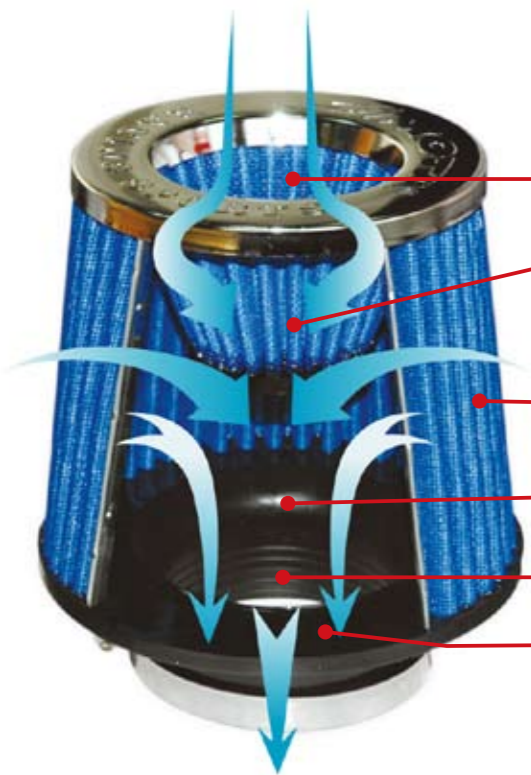

SIMOTA urethane air filter 360gm  
Traditional air filter 590gm  
Trimming down by 39%!

STRONG GALVANISED STEEL MESH BRIGHT EPOXY COATING

HIGH FLOW FILTER ELEMENT WITH FILTRATION PROTECTION

DEEP PLEATS / 3D PRECISION WEAVING TECHNOLOGY INCREASES 20% FILTER AREA

EXTREME BUILT-IN VELOCITY STACK

HIGH GRIP DESIGN FOR PERFECT FITMENT

TOP URETHANE BASE IS ONE-PIECE FORMED, ANTI-VIBRATION AND DURABLE / TOP URETHANE BASE CAN ENSURE THE TEMPERATURE FROM ENGINE BAY HEAT OVER 140°C

Simota Racing Sports is a manufacturer exporter specializing in high power intake system and car/motorbike air filters with Formula 1 grade technology

### Features:

Advanced polyurethane filter construction for lightweight and durability.

Temperature range from -30°C to 150°C (-22°F-302°F).

Strong galvanized steel mesh coated with bright Epoxy.

Unique 3D Precision Weaving Technology for constant, superior filtration.

More, deeper pleats for larger filtration surface.

Cleanable and reusable.

	Traditional Air Filter	SIMOTA urethane air filter
<b>Warranty</b>	•NO one	Million miles warranty!
<b>Weight</b>	•Heavy	Extremely lightweight
<b>Appearance</b>	•Soft aluminum mesh deforms easily •Old style	Strong galvanized steel mesh coated with Epoxy Bright, dashing look Anti-Rust
<b>Condition</b>	•Not good for use in bad condition (very cold / hot) or vibration environment •The filter body is easy to be separated from the base	It is impossible for the filter body to fall off from the filter base under all circumstances

## Comparison Between Traditional Air Filter & SIMOTA Urethane Air Filter

### Features:

Made of #304 stainless steel, with high hardness, corrosion resistant, one-piece formed, requiring no replacement at all, and environmentally friendly!

Temperature range from -30°C to 150°C (-22°F-302°F).

It only needs to be washed with water once every 10,000 kilometers.

The unit's strong flexibility also enables it to withstand high-pressure water jet during washing, suitable for long-term use and cost-effective.

Unique 3D Precision Weaving Technology for constant, superior filtration.

More, deeper pleats for large filtration surface.

Cleanable and reusable.

	Traditional Air Filter	SIMOTA urethane air filter
<b>Warranty</b>	•NO one	•Million miles warranty!
<b>Weight</b>	•Heavy	•Extremely lightweight
<b>Appearance</b>	•Soft aluminum mesh deforms easily •Old style	•#304 Stainless steel •Bright, dashing look •Anti-Rust
<b>Condition</b>	•Not good for use in bad condition (very cold / hot) or vibration environment •The filter body is easy to be separated from the base	•It is impossible for the filter body to fall off from the filter base under all circumstances

## FLAT NCAP 360 URETHANE

Please refer to the detailed item No. of Urethane air filter listed in P10



JAU-E01201-07

ITEM NO.	Width(mm)	Height(mm)	Neck(mm)	MSRP
JAU-E01201-07	140	145	80	
JAU-F01201-07	140	145	84	
JAU-G01201-07	140	145	89	



JAU-A02201-05

ITEM NO.	Width(mm)	Height(mm)	Neck(mm)	MSRP
JAU-A02201-05	151	130	60	
JAU-B02201-05	151	130	65	
JAU-C02201-05	151	130	70	
JAU-D02201-05	151	130	77	
JAU-E02201-05	151	130	80	
JAU-F02201-05	151	130	84	
JAU-G02201-05	151	130	89	
JAU-H02201-05	151	130	101	
JAU-I02201-05	151	130	114	



JAU-A02201-20

ITEM NO.	Width(mm)	Height(mm)	Neck(mm)	MSRP
JAU-A02201-20	151	65	60	
JAU-B02201-20	151	65	65	
JAU-C02201-20	151	65	70	
JAU-D02201-20	151	65	77	
JAU-E02201-20	151	65	80	
JAU-F02201-20	151	65	84	
JAU-G02201-20	151	65	89	
JAU-H02201-20	151	65	101	
JAU-I02201-20	151	65	114	



JAU-A02201-06

ITEM NO.	Width(mm)	Height(mm)	Neck(mm)	MSRP
JAU-A02201-06	151	140	60	
JAU-B02201-06	151	140	65	
JAU-C02201-06	151	140	70	
JAU-D02201-06	151	140	77	
JAU-E02201-06	151	140	80	
JAU-F02201-06	151	140	84	
JAU-G02201-06	151	140	89	
JAU-H02201-06	151	140	101	
JAU-I02201-06	151	140	114	



JAU-A02201-11

ITEM NO.	Width(mm)	Height(mm)	Neck(mm)	MSRP
JAU-A02201-11	151	180	60	
JAU-B02201-11	151	180	65	
JAU-C02201-11	151	180	70	
JAU-D02201-11	151	180	77	
JAU-E02201-11	151	180	80	
JAU-F02201-11	151	180	84	
JAU-G02201-11	151	180	89	
JAU-H02201-11	151	180	101	
JAU-I02201-11	151	180	114	



JAU-A02201-15

ITEM NO.	Width(mm)	Height(mm)	Neck(mm)	MSRP
JAU-A02201-15	151	220	60	
JAU-B02201-15	151	220	65	
JAU-C02201-15	151	220	70	
JAU-D02201-15	151	220	77	
JAU-E02201-15	151	220	80	
JAU-F02201-15	151	220	84	
JAU-G02201-15	151	220	89	
JAU-H02201-15	151	220	101	
JAU-I02201-15	151	220	114	



JAU-I04201-03/JAU-I04201-05

ITEM NO.	Width(mm)	Height(mm)	Neck(mm)	MSRP
JAU-I04201-03	170	110	114	
JAU-I04201-05	170	130	114	



JAU-K05201-03/JAU-K05201-05

ITEM NO.	Width(mm)	Height(mm)	Neck(mm)	MSRP
JAU-K05201-03	190	110	152	
JAU-K05201-05	190	130	152	

**SIMOTA**  
urethane air filter 360gm  
Traditional air filter 590gm  
Trimming down by 39%!





# URETHANE AIR FILTER

**DOUBLE INLET 360 URETHANE** Please refer to the detailed item No. of Urethane air filter listed in P10

AIR FILTER



COLOR  
red  
blue  
stainless



COLOR  
red  
blue  
stainless



COLOR  
red  
blue  
stainless

**JAU-A12209-05**

ITEM NO.	Width(mm)	Height(mm)	Neck(mm)	MSRP
JAU-A02201-06	151	140	60	
JAU-B02201-06	151	140	65	
JAU-H02201-06	151	140	101	
JAU-I02201-06	151	140	114	

**JAU-E01202-07**

ITEM NO.	Width(mm)	Height(mm)	Neck(mm)	MSRP
JAU-A02201-06	151	140	60	
JAU-H02201-06	151	140	101	
JAU-I02201-06	151	140	114	

**JAU-G08209-05**

ITEM NO.	Width(mm)	Height(mm)	Neck(mm)	MSRP
JAU-A02201-06	151	140	60	
JAU-H02201-06	151	140	101	
JAU-I02201-06	151	140	114	



COLOR  
red  
blue  
stainless



COLOR  
red  
blue  
stainless



COLOR  
red  
blue  
stainless

**JAU-A02202-05**

ITEM NO.	Width(mm)	Height(mm)	Neck(mm)	MSRP
JAU-A02202-05	151	130	60	
JAU-B02202-05	151	130	65	
JAU-C02202-05	151	130	70	
JAU-D02202-05	151	130	77	
JAU-E02202-05	151	130	80	
JAU-F02202-05	151	130	84	
JAU-G02202-05	151	130	89	
JAU-H02202-05	151	130	101	
JAU-I02202-05	151	130	114	

**JAU-A02202-06**

ITEM NO.	Width(mm)	Height(mm)	Neck(mm)	MSRP
JAU-A02202-06	151	140	60	
JAU-B02202-06	151	140	65	
JAU-C02202-06	151	140	70	
JAU-D02202-06	151	140	77	
JAU-E02202-06	151	140	80	
JAU-F02202-06	151	140	84	
JAU-G02202-06	151	140	89	
JAU-H02202-06	151	140	101	
JAU-I02202-06	151	140	114	

**JAU-A02203-05**

ITEM NO.	Width(mm)	Height(mm)	Neck(mm)	MSRP
JAU-A02203-05	151	130	60	
JAU-B02203-05	151	130	65	
JAU-C02203-05	151	130	70	
JAU-D02203-05	151	130	77	
JAU-E02203-05	151	130	80	
JAU-F02203-05	151	130	84	
JAU-G02203-05	151	130	89	
JAU-H02203-05	151	130	101	
JAU-I02203-05	151	130	114	



COLOR  
red  
blue  
stainless



COLOR  
red  
blue  
stainless



COLOR  
red  
blue  
stainless

**JAU-A02209-05**

ITEM NO.	Width(mm)	Height(mm)	Neck(mm)	MSRP
JAU-A02209-05	151	130	60	
JAU-B02209-05	151	130	65	
JAU-C02209-05	151	130	70	
JAU-D02209-05	151	130	77	
JAU-E02209-05	151	130	80	
JAU-F02209-05	151	130	84	
JAU-G02209-05	151	130	89	
JAU-H02209-05	151	130	101	
JAU-I02209-05	151	130	114	

**JAU-I04202-03/JAU-I04202-05**

ITEM NO.	Width(mm)	Height(mm)	Neck(mm)	MSRP
JAU-I04202-03	170	110	114	
JAU-I04202-05	170	130	114	

**JAU-K05202-03/JAU-K05202-05**

ITEM NO.	Width(mm)	Height(mm)	Neck(mm)	MSRP
JAU-K05202-03	190	110	152	
JAU-K05202-05	190	130	152	

# URETHANE AIR FILTER

**OTHERS 360 URETHANE** Please refer to the detailed item No. of Urethane air filter listed in P10



COLOR  
red  
blue  
stainless



COLOR  
red  
blue  
stainless



**JAU-A02205-05**

ITEM NO.	Width(mm)	Height(mm)	Neck(mm)	MSRP
JAU-A02202-05	151	130	60	
JAU-B02202-05	151	130	65	
JAU-C02202-05	151	130	70	
JAU-D02202-05	151	130	77	
JAU-E02202-05	151	130	80	
JAU-F02202-05	151	130	84	
JAU-G02202-05	151	130	89	
JAU-H02202-05	151	130	101	
JAU-I02202-05	151	130	114	

**JAU-A02208-05**

ITEM NO.	Width(mm)	Height(mm)	Neck(mm)	MSRP
JAU-A02208-05	151	130	60	
JAU-B02208-05	151	130	65	
JAU-C02208-05	151	130	70	
JAU-D02208-05	151	130	77	
JAU-E02208-05	151	130	80	
JAU-F02208-05	151	130	84	
JAU-G02208-05	151	130	89	
JAU-H02208-05	151	130	101	
JAU-I02208-05	151	130	114	

**JAU-A02231-05**

ITEM NO.	Width(mm)	Height(mm)	Neck(mm)	MSRP
JAU-A02231-05	151	130	60	
JAU-B02231-05	151	130	65	
JAU-C02231-05	151	130	70	
JAU-D02231-05	151	130	77	
JAU-E02231-05	151	130	80	
JAU-F02231-05	151	130	84	
JAU-G02231-05	151	130	89	
JAU-H02231-05	151	130	101	
JAU-I02231-05	151	130	114	



COLOR  
red  
blue  
stainless



COLOR  
red  
blue  
stainless



COLOR  
red  
blue  
stainless

**JAU-A02206-05**

ITEM NO.	Width(mm)	Height(mm)	Neck(mm)	MSRP
JAU-A02206-05	151	130	60	
JAU-B02206-05	151	130	65	
JAU-C02206-05	151	130	70	
JAU-D02206-05	151	130	77	
JAU-E02206-05	151	130	80	
JAU-F02206-05	151	130	84	
JAU-G02206-05	151	130	89	
JAU-H02206-05	151	130	101	
JAU-I02206-05	151	130	114	

**JAU-A02206-20**

ITEM NO.	Width(mm)	Height(mm)	Neck(mm)	MSRP
JAU-A02206-20	151	65	60	
JAU-B02206-20	151	65	65	
JAU-C02206-20	151	65	70	
JAU-D02206-20	151	65	77	
JAU-E02206-20	151	65	80	
JAU-F02206-20	151	65	84	
JAU-G02206-20	151	65	89	
JAU-H02206-20	151	65	101	
JAU-I02206-20	151	65	114	

**JAU-A02229-20**

ITEM NO.	Width(mm)	Height(mm)	Neck(mm)	MSRP
JAU-A02229-20	151	65	60	
JAU-B02229-20	151	65	65	
JAU-C02229-20	151	65	70	
JAU-D02229-20	151	65	77	
JAU-E02229-20	151	65	80	
JAU-F02229-20	151	65	84	
JAU-G02229-20	151	65	89	
JAU-H02229-20	151	65	101	
JAU-I02229-20	151	65	114	



**JAU-G08208-05**

ITEM NO.	Width(mm)	Height(mm)	Neck(mm)	MSRP
JAU-G08208-05	146	130	89	

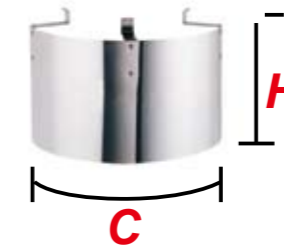

**SH-01**

ITEM NO.	C (mm)	Height(mm)	MSRP
SH-01	310	140	
SH-02	310	243	
SH-03	310	195	
SH-04	295	155	
SH-05	260	167	
SH-06	100	55	
SH-07	310	220	



**WS-247**

ITEM NO.	Width(mm)	Height(mm)	Neck(mm)	MSRP
WS-247-1	150	130	77	
WS-247-2	150	130	60	
WS-247-3	150	130	65	
WS-247-4	150	130	70	
WS-247-5	150	130	84	
WS-247-6	150	130	114	
WS-247-7	150	130	50.8	

AIR FILTER



# URETHANE AIR FILTER

## OTHERS 360 URETHANE Please refer to the detailed item No. of Urethane air filter listed in P10

**WS-002(METAL BASE)**

ITEM NO.	Width(mm)	Height(mm)	Neck(mm)	MSRP
WS-002-1	150	130	77	
WS-002-2	150	130	70	
WS-002-3	150	130	65	
WS-002-4	150	130	70	
WS-002-5	150	130	84	
WS-002-6	150	130	114	
WS-002-7	150	130	50.8	

**WS-018A/022A(METAL BASE)**

ITEM NO.	Width(mm)	Height(mm)	Neck(mm)	MSRP
WS-018A-1	150	180	77	
WS-018A-2	150	180	84	
WS-018A-3	150	180	114	
WS-022A-1	150	220	77	
WS-022A-2	150	220	84	
WS-022A-3	150	220	114	

**WS-190**

ITEM NO.	Width(mm)	Height(mm)	Neck(mm)	MSRP
WS-190-1	150	130	77	
WS-190-2	150	130	60	
WS-190-3	150	130	63.5 ruberbase only	
WS-190-4	150	130	65	
WS-190-5	150	130	70	
WS-190-6	150	130	84	
WS-190-7	150	130	114	
WS-190-8	150	130	50.8	

Available in Red/ Blue/ Chrome(Top cap)  
Stainless steel filter is 125mm tall

**WS-190TW**

ITEM NO.	Width(mm)	Height(mm)	Neck(mm)	MSRP
WS-190TW-1	150	130	77	
WS-190TW-2	150	130	60	
WS-190TW-3	150	130	63.5 ruberbase only	
WS-190TW-4	150	130	65	
WS-190TW-5	150	130	70	
WS-190TW-6	150	130	84	
WS-190TW-7	150	130	114	
WS-190TW-8	150	130	50.8	

Available in Red/ Blue/ Chrome(Top cap)  
Stainless steel filter is 125mm tall

## MINI

JAU-L13223-21 JAU-M14223-21 JAU-N15223-21 JAU-O16223-21 JAU-P17223-21 JAU-Q18223-21

Neck(mm)25 Neck(mm)20 Neck(mm)18 Neck(mm)15 Neck(mm)12 Neck(mm)9

Mini Air filter relieves your engine of positive crankcase pressure and recycled carbon vapors from your engine, which cause loss of throttle response due to build-up on the throttle body. By venting the vapors into the atmosphere, the Mini Air Filter helps resolve that problem. SIMOTA specially develops various of bolts for mini air filter the different neck diameters. You can now easily install the mini air filter on however hard or soft tube.

ITEM NO.	Width(mm)	Height(mm)	Neck(mm)	MSRP
JAU-Q18223-21	50	35	9	
JAU-P17223-21	50	35	12	
JAU-O16223-21	50	35	15	
JAU-N15223-21	50	35	18	
JAU-M14223-21	50	35	20	
JAU-L13223-21	50	35	25	



# URETHANE AIR FILTER

## STAINLESS-STEEL STOCK REPLACEMENT AIR FILTER

Features:

- Made of #304 stainless steel, with high hardness, corrosion resistant, one-piece formed, requiring no replacement at all, and environmentally friendly!
- Temperature range from -30°C to 150°C (-22°F~302°F).
- It only needs to be washed with water once every 10,000 kilometers.
- The unit's strong flexibility also enables it to withstand high-pressure water jet during washing, suitable for long-term use and cost-effective.
- Unique 3D Precision Weaving Technology for constant, superior filtration.
- More, deeper pleats for large filtration surface. Cleanable and reusable.

## FLAT NCAP 360 URETHANE Please refer to the detailed item No. of Urethane air filter listed in P10

**JAU-A02501-18**

ITEM NO.	Width(mm)	Height(mm)	Neck(mm)	MSRP
JAU-A02501-18	151	125	60	
JAU-B02501-18	151	125	65	
JAU-C02501-18	151	125	70	
JAU-D02501-18	151	125	77	
JAU-E02501-18	151	125	80	
JAU-F02501-18	151	125	84	
JAU-G02501-18	151	125	89	
JAU-H02501-18	151	125	101	
JAU-I02501-18	151	125	114	

**JAU-A02501-20**

ITEM NO.	Width(mm)	Height(mm)	Neck(mm)	MSRP
JAU-A02501-20	151	65	60	
JAU-B02501-20	151	65	65	
JAU-C02501-20	151	65	70	
JAU-D02501-20	151	65	77	
JAU-E02501-20	151	65	80	
JAU-F02501-20	151	65	84	
JAU-G02501-20	151	65	89	
JAU-H02501-20	151	65	101	
JAU-I02501-20	151	65	114	

**JAU-I04501-03/JAU-I04501-18**

ITEM NO.	Width(mm)	Height(mm)	Neck(mm)	MSRP
JAU-I04501-03	170	110	114	
JAU-I04501-18	170	125	114	

**JAU-K05501-03/JAU-K05501-18**

ITEM NO.	Width(mm)	Height(mm)	Neck(mm)	MSRP
JAU-K05501-03	190	110	152	
JAU-K05501-18	190	125	152	

## DOUBLE INLET

**JAU-A02502-18**

ITEM NO.	Width(mm)	Height(mm)	Neck(mm)	MSRP
JAU-A02502-18	151	125	60	
JAU-B02502-18	151	125	65	
JAU-C02502-18	151	125	70	
JAU-D02502-18	151	125	77	
JAU-E02502-18	151	125	80	
JAU-F02502-18	151	125	84	
JAU-G02502-18	151	125	89	
JAU-H02502-18	151	125	101	
JAU-I02502-18	151	125	114	

**JAU-A12509-18**

ITEM NO.	Width(mm)	Height(mm)	Neck(mm)	MSRP
JAU-A12509-18	120	25	60	
JAU-B12509-18	120	25	65	
JAU-C12509-18	120	25	70	
JAU-D12509-18	120	25	77	

## OTHERS

**JAU-A02506-18**

ITEM NO.	Width(mm)	Height(mm)	Neck(mm)	MSRP
JAU-A02506-18	151	125	60	
JAU-B02506-18	151	125	65	
JAU-C02506-18	151	125	70	
JAU-D02506-18	151	125	77	
JAU-E02506-18	151	125	80	
JAU-F02506-18	151	125	84	
JAU-G02506-18	151	125	89	
JAU-H02506-18	151	125	101	
JAU-I02506-18	151	125	114	

**JAU-A02506-20**

ITEM NO.	Width(mm)	Height(mm)	Neck(mm)	MSRP
JAU-A02506-20	151	65	60	
JAU-B02506-20	151	65	65	
JAU-C02506-20	151	65	70	
JAU-D02506-20	151	65	77	
JAU-E02506-20	151	65	80	
JAU-F02506-20	151	65	84	
JAU-G02506-20	151	65	89	
JAU-H02506-20	151	65	101	
JAU-I02506-20	151	65	114	



# SIMOTA URETHANE AIR FILTER

AIR FILTER

## HEAT SHIELD

PC MATERIAL HEAT-SHIELD ENDURES HIGH TEMPERATURE UP TO 280°C

- BELL SHAPED CAP
- STRONG GALVANISED STEEL MESH W / BRIGHT EPOXY COATING
- DEEP PLEATS / 3DPRECISION WEAVING TECHNOLOGY INCREASES 20% FILTRATION AREA
- HIGH FLOW FILTER ELEMENT WITH FILTRATION PROTECTION
- THE SHIELD REDUCES HEAT BUILD-UP. FEEDS ONLE COOL AIR INTO THE ENGINE
- EXTREME BUILT-IN VELOCITY STACK
- HIGH GRIP DESIGN FOR PERFECT FITMENT

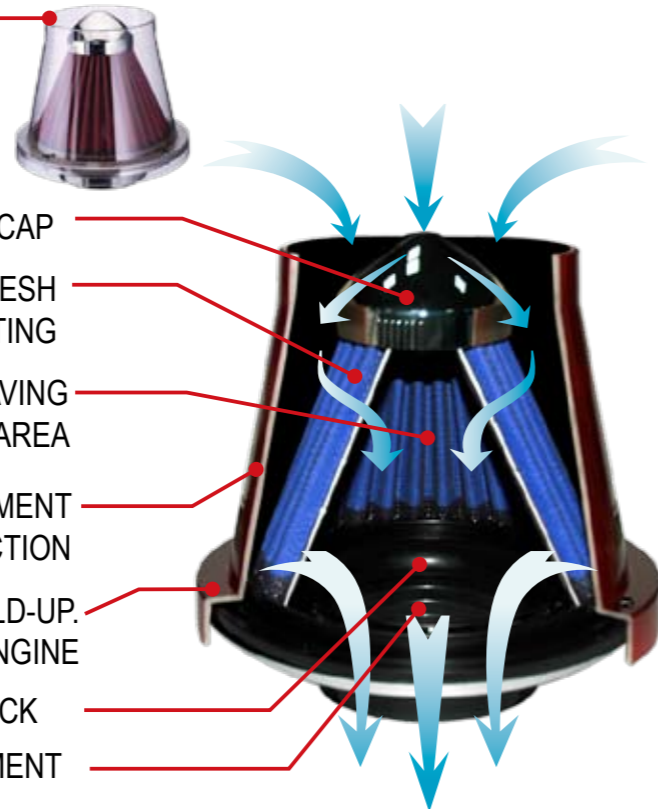

The SIMOTA heat shield air filter is a universal cold air intake system incorporating a cleanable / reusable. SIMOTA High-Flow Air Filter. The shield reduces heat build-up feeding only cool air to your engine, resulting in improved volumetric efficiency and increased power gains. It allows for updating your intake system while retaining a closed environment.

### WS-007 (CHROME/CARBON/RED/BLUE/YELLOW)

ITEM NO.	Width(mm)	Height(mm)	Neck(mm)	MSRP
WS-007-1	165	175	77	
WS-007-2	165	175	60	
WS-007-3	165	175	65	
WS-007-4	165	175	70	
WS-007-5	165	175	84	
WS-007-6	165	175	50.8	
WS-007-7	165	175	114	

### WS-007T (TRANSPARENT RED/BLUE/YELLOW /GRAY)

ITEM NO.	Width(mm)	Height(mm)	Neck(mm)	MSRP
WS-007T-1	165	175	77	
WS-007T-2	165	175	60	
WS-007T-3	165	175	65	
WS-007T-4	165	175	70	
WS-007T-5	165	175	84	
WS-007T-6	165	175	50.8	
WS-007T-7	165	175	114	

### WS-009 (CHROME/RED/BLUE/YELLOW)

ITEM NO.	Width(mm)	Height(mm)	Neck(mm)	MSRP
WS-009-1	165	80	77	
WS-009-2	165	80	60	
WS-009-3	165	80	65	
WS-009-4	165	80	70	
WS-009-5	165	80	84	
WS-009-6	165	80	50.8	
WS-009-7	165	80	114	



# SIMOTA URETHANE AIR FILTER



## HEAT SHIELD

STAINLESS

HIGHFLOW FILTER ELEMENT WITH FILTRATION PROTECTION

PC MATERIAL HEAT-SHIELD ENDURES HIGH TEMPERATURE UP TO 280°C

- BELL SHAPED CAP
- HIGH FLOW FILTER ELEMENT WITH FILTRATION PROTECTION
- MADE OF #304 STAINLESS STEEL
- DEEP PLEATS / 3D PRECISION WEAVING TECHNOLOGY INCREASES 20% FILTER AREA
- THE SHIELD REDUCES HEAT BUILD-UP FEEDING ONLY COOL AIR TO ENGINE

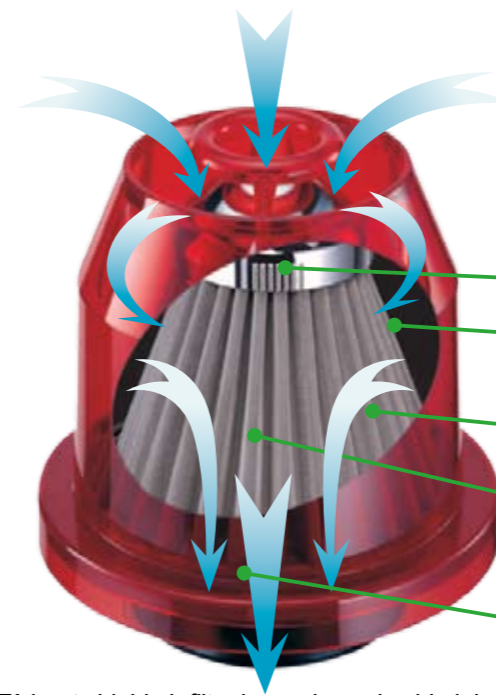

The SIMOTA heat shield air filter is a universal cold air intake system incorporating a cleanable / reusable. SIMOTA High-Flow Air Filter. The shield reduces heat build-up feeding only cool air to your engine, resulting in improved volumetric efficiency and increased power gains. It allows for updating your intake system while retaining a closed environment.

### WS-240

### WS-241T



### WS-242

### WS-243



### WS-240 (CHROME/CARBON/RED/BLUE/YELLOW)

ITEM NO.	Width(mm)	Height(mm)	Neck(mm)	MSRP
WS-240-1	165	170	77	
WS-240-2	165	170	60	
WS-240-3	165	170	65	
WS-240-4	165	170	70	
WS-240-5	165	170	84	
WS-240-6	165	170	50.8	

### WS-241T (TRANSPARENT RED/BLUE/YELLOW)

ITEM NO.	Width(mm)	Height(mm)	Neck(mm)	MSRP
WS-241T-1	150	165	77	
WS-241T-2	150	165	60	
WS-241T-3	150	165	65	
WS-241T-4	150	165	70	
WS-241T-5	150	165	84	
WS-241T-6	150	165	50.8	

### WS-242 (CHROME/CARBON/RED/BLUE/YELLOW)

ITEM NO.	Width(mm)	Height(mm)	Neck(mm)	MSRP
WS-242-1	165	175	77	
WS-242-2	165	175	60	
WS-242-3	165	175	65	
WS-242-4	165	175	70	
WS-242-5	165	175	84	
WS-242-6	165	175	63.5	

### WS-243 (CHROME/RED/BLUE/YELLOW/SILVER)

ITEM NO.	Width(mm)	Height(mm)	Neck(mm)	MSRP
WS-243-1	150	165	77	
WS-243-2	150	165	60	
WS-243-3	150	165	65	
WS-243-4	150	165	70	
WS-243-5	150	165	84	
WS-243-6	150	165	50.8	

AIR FILTER



## HEAT SHIELD

The SIMOTA heat shield air filter is an universal cold air intake system incorporating a cleanable / reusable.

SIMOTA High-Flow Air Filter. The shield reduces heat build-up feeding only cool air to your engine, resulting in improved volumetric efficiency and increased power gains. It allows for updating your intake system while retaining a closed environment.



### H2 (CHROME/CARBON/RED/BLUE/YELLOW)

ITEM NO.	Width(mm)	Height(mm)	Neck(mm)	MSRP
H2-9	56	35	9	
H2-12	56	35	12	
H2-25	56	35	25	

### H3 (CHROME/CARBON)

ITEM NO.	Width(mm)	Height(mm)	Neck(mm)	MSRP
H3-9	56	35	9	
H3-12	56	35	12	
H3-25	56	35	25	

### H3L (CHROME/CARBON)

ITEM NO.	Width(mm)	Height(mm)	Neck(mm)	MSRP
H3L-9	56	35	9	
H3L-12	56	35	12	



### H2L (CHROME/CARBON/RED/BLUE/YELLOW)

ITEM NO.	Width(mm)	Height(mm)	Neck(mm)	MSRP
H2L-9	56	35	9	
H2L-12	56	35	12	

### H3T (RED/BLUE/YELLOW)

ITEM NO.	Width(mm)	Height(mm)	Neck(mm)	MSRP
H3T-9	56	35	9	
H3T-12	56	35	12	
H3T-25	56	35	25	

### H3LT (RED/BLUE/YELLOW)

ITEM NO.	Width(mm)	Height(mm)	Neck(mm)	MSRP
H3LT-9	56	35	9	
H3LT-12	56	35	12	



## MUSHROOM

STRONG CRUTCH LIGHTWEIGHT AND DURABLE WASH EASILY

SPIRAL STRAIGHT-FIN DESIGN LIGHTWEIGHT AND DURABLE WASH EASILY

VACUUM-INDUCING INNER HORN UNIQUE-FUNNEL DESIGN

HIGH GRIP DESIGN FOR PERFECT FITMENT

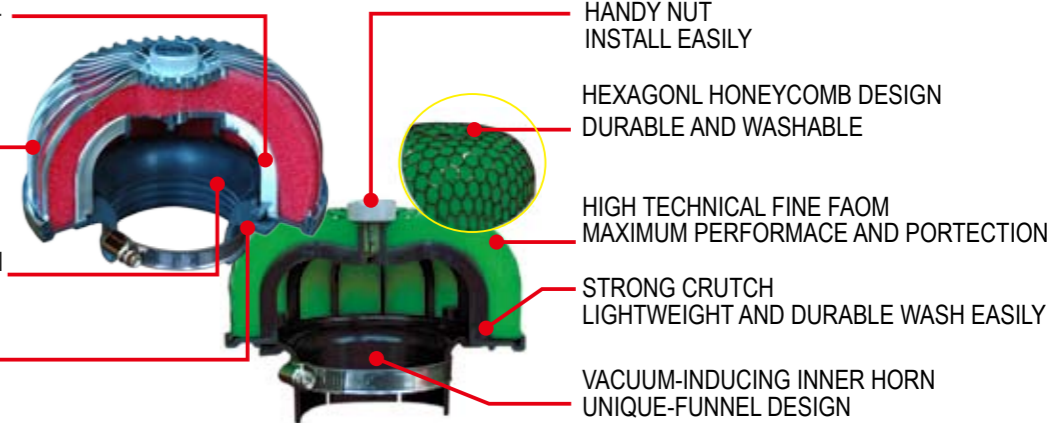

HANDY NUT INSTALL EASILY

HEXAGONL HONEYCOMB DESIGN DURABLE AND WASHABLE

HIGH TECHNICAL FINE FAOM MAXIMUM PERFORMACE AND PORTECTION

STRONG CRUTCH LIGHTWEIGHT AND DURABLE WASH EASILY

VACUUM-INDUCING INNER HORN UNIQUE-FUNNEL DESIGN

### MUSHROOM > HEXAGON

#### WS-245 (GREEN/RED/BLUE)

ITEM NO.	Width(mm)	Height(mm)	Neck(mm)	MSRP
WS-245-1	165	120	77	
WS-245-2	165	120	60	
WS-245-3	165	120	65	
WS-245-4	165	120	70	



Available for universal applications, the unique design of SIMOTA HEXAGON MUSHROOM SIMOTA SPIRAL MUSHROOM com bats the typical stock design That generates turbulence and reduces airflow capacity when the propensity of airflow moves towardssurface areas.

SIMOTA HEXAGON MUSHROOM / SIMOTA SPIRAL MUSHROOM is made up of a fine foam which offer an optimal balance of air filtration and increased airflow for maximum performance and protection.

### MUSHROOM > SPIRAL

#### WS-245 (GREEN/RED/BLUE)

ITEM NO.	Width(mm)	Height(mm)	Neck(mm)	MSRP
WS-246-1	165	120	77	
WS-246-2	165	120	60	
WS-246-3	165	120	65	
WS-246-4	165	120	70	



SIMOTA'S unique-funnel design, with its vacuum-inducing inner horn, drawsair from the filter's outer edge and directs air away from inlet throat surface areas.

The outer cage design which helps promote air intake.

The streamline design and the colorful outlooking can dress up any high performance engine compartment.

### REPLACEMENT FILTER ELEMENTS

ITEM NO.	DIAMETER	MSRP
OP-03B	φ245mm	

ITEM NO.	DIAMETER	MSRP
OP-03G	φ245mm	

ITEM NO.	DIAMETER	MSRP
OP-03R	φ245mm	



#### Replacement Filter Elements

\*Hot high performance car parts! Gain HP with this high performance intake air filter.

Replacement Filter Elements are available in oil-resistance proof construction. The impregnated with our unique type is standard in Spiral Straight-Fin or Hexagonal Honeycomb model reloaded intake kits, and is designed for superior filtration while still providing excellent airflow. The foam is made up of new patent formula in Racing Suction kits and is focused on maximizing airflow for performance and protection, yet still keeping harmful particles from the engine.



ITEM NO.	DESCRIPTION	MSRP
W-008A	CARBURETOR 60MM	
W-008B	CARBURETOR 69MM	
H-012	HONDA CIVIC CARBURETOR 88-91	
LD-03	LADA CARBURETOR	
LD-05	LADA CARBURETOR	
PK-001	PERODUA KANCIL CARBURETOR	
M-005A	PROTON WIRA 12V	
M-006A	PROTON WIRA 8V 69MM	
M-005B	PROTON WIRA 12V	
M-006B	PROTON WIRA 8V 69MM	
T-013	TOYOTA ZACE CARBURETOR 60MM	
T-014	TOYOTA KIJANG CARBURETOR 60MM	

PK-001



TOP CAP FOR

ITEM NO.	MSRP
M-005B	
M-006B	
LD-05	

CARB-01

ITEM NO.	NECK	INNER	HEIGHT	MSRP
CARB-01	229mm x	196mm	x 51mm	

CARB-02

ITEM NO.	NECK	INNER	HEIGHT	MSRP
CARB-02	194mm x	166mm	x 51mm	



BASE SHAPE FOR M-005B

BASE SHAPE FOR M-006B

BASE SHAPE FOR LD-05



TOP CAP FOR

ITEM NO.	MSRP	ITEM NO.	MSRP
M-005A		T-013	
M-006A		T-014	
W-008A		H-012	
W-008B		LD-03	

BASE SHAPE FOR M-005A



BASE SHAPE FOR M006A/W008A/W008B/T-013/T-014

BASE SHAPE FOR H-012

BASE SHAPE FOR LD-03

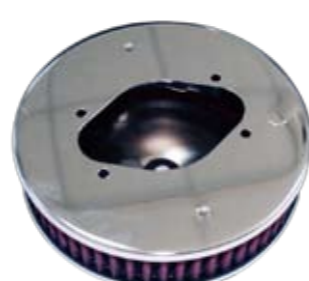

ITEM NO.	VEHICLE MODEL	YEARS	MSRP
<b>EUROPEAN CAR MODEL</b>			
MWS9335	MINI AUSTIN CARBURETOR (ø32mm)	Pre-90	
MWS9320	MINI AUSTIN CARBURETOR (ø35mm)	Pre-90	
MWS9327	MINI AUSTIN CARBURETOR (ø42mm)	Pre-90	
MWS9330	MINI AUSTIN CARBURETOR (ø48mm)	Pre-90	



**PO218B**

## PROJECT GOLF

ITEM NO.	VEHICLE MODEL/YEARS	MSRP
PO218D	GOLF II 1.8 8V / 89-91	
PO218B	GOLF II GTI 1.8 16V 89+	
PO218C	GOLF II GTI 1.8 16V / 89-90	
PO318A	GOLF III 1.8 8V / 92-98, SEAT BARCELONA CL4 1.8 / 93-97	
PO320B	GOLF III 2.0 / 95-98	
PO416A	GOLF IV 1.6 / 99-03	
PO420A	GOLF IV 2.0 / 98-03, BORA 2.0 / 98-ON, BEETLE 2.0 / 00-ON	

**PO218B FOR GOLF II 1.8 16V 89-90**





# SIMOTA URETHANE AIR FILTER

## CARBON FIBER LIGHTWEIGHT FILTER

The lightweight carbon fiber filter with a cylindrical carbon air box features an internal washable filter element.

A black elastic ducting (70cm length) for bending any angles and aero horn, which connected to the carbon fiber direct the external cold air flow through the filter and into the engine.



### Nonwoven Fabric Element

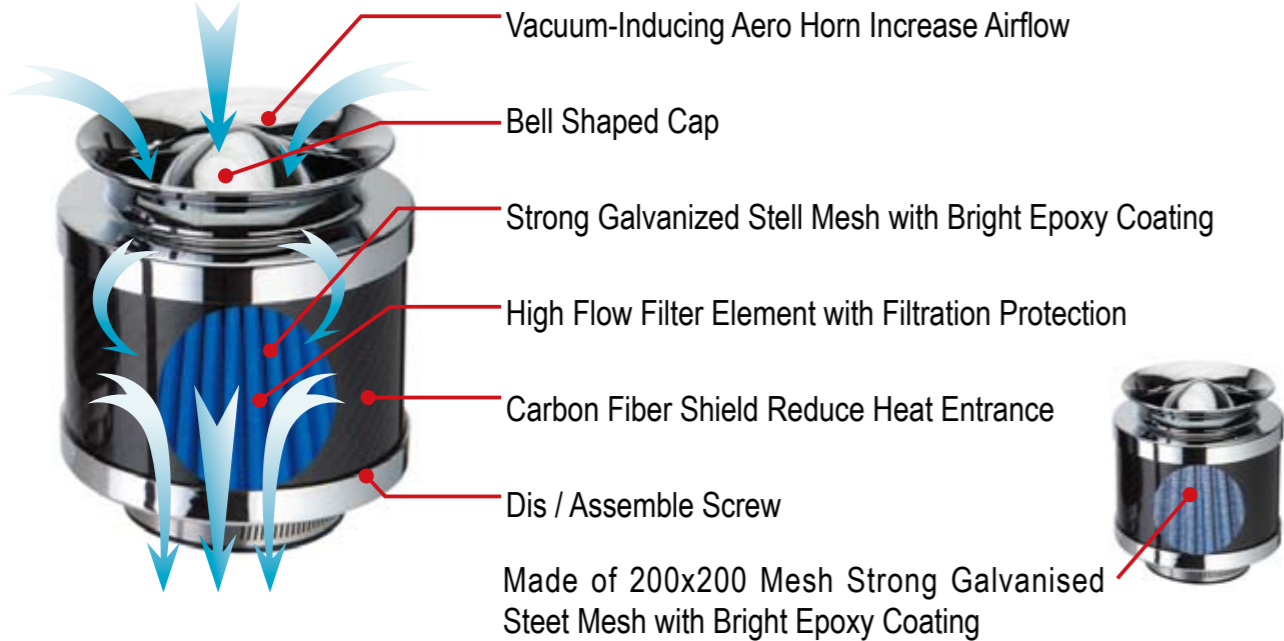

WS-251S Nonwoven Fabric element					WS-251M Nonwoven Fabric element					WS-251L Nonwoven Fabric element				
ITEM NO.	Width(mm)	Height(mm)	Neck(mm)	MSRP	ITEM NO.	Width(mm)	Height(mm)	Neck(mm)	MSRP	ITEM NO.	Width(mm)	Height(mm)	Neck(mm)	MSRP
WS-251S-1	130	125	60		WS-251M-1	130	155	60		WS-251L-1	130	175	60	
WS-251S-2	130	125	65		WS-251M-2	130	155	65		WS-251L-2	130	175	65	
WS-251S-3	130	125	70		WS-251M-3	130	155	70		WS-251L-3	130	175	70	
WS-251S-4	130	125	77		WS-251M-4	130	155	77		WS-251L-4	130	175	77	

WS-251SS Nonwoven Fabric Element Stainless-steel element					WS-251SM Nonwoven Fabric Element Stainless-steel element					WS-251SL Nonwoven Fabric Element Stainless-steel element				
ITEM NO.	Width(mm)	Height(mm)	Neck(mm)	MSRP	ITEM NO.	Width(mm)	Height(mm)	Neck(mm)	MSRP	ITEM NO.	Width(mm)	Height(mm)	Neck(mm)	MSRP
WS-251SS-1	130	125	60		WS-251SM-1	130	155	60		WS-251SL-1	130	175	60	
WS-251SS-2	130	125	65		WS-251SM-2	130	155	65		WS-251SL-2	130	175	65	
WS-251SS-3	130	125	70		WS-251SM-3	130	155	70		WS-251SL-3	130	175	70	
WS-251SS-4	130	125	77		WS-251SM-4	130	155	77		WS-251SL-4	130	175	77	

# AIR INTAKE SYSTEM

## UNIVERSAL CARBON FIBER LIGHTWEIGHT FILTER

The lightweight carbon fiber filter with a cylindrical carbon air box features an internal washable filter element. A black elastic ducting (70cm length) for bending any angles and aero horn, which connected to the carbon fiber direct the external cold air flow through the filter and into the engine.



### WS-253/WS-254

ITEM NO.	Width(mm)	Height(mm)	Neck(mm)	MSRP
WS-253-1	130	186.5	70	
WS-253-2	130	186.5	77	
WS-254-1	130	150	70	
WS-254-2	130	150	77	

### WS-553/WS-554

ITEM NO.	Width(mm)	Height(mm)	Neck(mm)	MSRP
WS-553-3	150	186.5	70	
WS-553-4	150	186.5	77	
WS-553-5	150	186.5	70	
WS-553-6	150	186.5	84	
WS-553-7	150	186.5	89	
WS-554-3	150	150	70	
WS-554-4	150	150	77	
WS-554-5	150	150	80	
WS-554-6	150	150	84	
WS-554-7	150	150	89	

### BB-253

ITEM NO.	Width(mm)	Height(mm)	Neck(mm)	MSRP
BB-253-1	130	186.5	70	
BB-253-2	130	186.5	77	

### BB-254

ITEM NO.	Width(mm)	Height(mm)	Neck(mm)	MSRP
BB-254-1	130	150	70	
BB-254-2	150	186.5	77	

### BB-553

ITEM NO.	Width(mm)	Height(mm)	Neck(mm)	MSRP
BB-553-3	150	186.5	70	
BB-553-4	150	186.5	77	
BB-553-5	150	186.5	80	
BB-553-6	150	186.5	84	
BB-553-7	150	186.5	89	

### BB-554

ITEM NO.	Width(mm)	Height(mm)	Neck(mm)	MSRP
BB-554-3	150	150	70	
BB-554-4	150	150	77	
BB-554-5	150	150	80	
BB-554-6	150	150	84	
BB-554-7	150	150	89	

### BBN-253

ITEM NO.	Width(mm)	Height(mm)	Neck(mm)	MSRP
BBN-253-1	130	145	70	
BBN-253-2	130	145	77	

### BBN-254

ITEM NO.	Width(mm)	Height(mm)	Neck(mm)	MSRP
BBN-254-1	130	110	70	
BBN-254-2	130	110	77	

### BBN-553

ITEM NO.	Width(mm)	Height(mm)	Neck(mm)	MSRP
BBN-553-3	150	130	70	
BBN-553-4	150	130	77	
BBN-553-5	150	130	80	
BBN-553-6	150	130	84	
BBN-553-7	150	130	89	

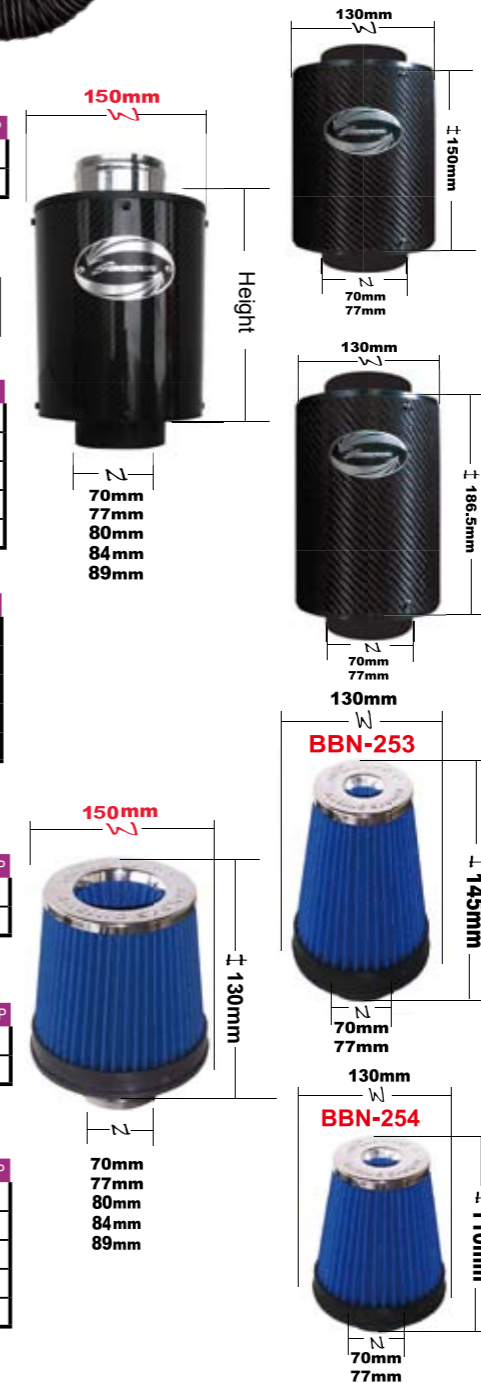

## BLACK ELASTIC DUCT

**BLACK ELASTIC DUCT**  
Bendable fiber duct with steel wire knitted inside make tube strong & elastic suitable for any angle. High & Low temperature enduring. Anti-explosion. Helps induce maximum cool air outside the car to the cylinders to achieve fuel combustion. Suitable for any Cars.

### FITS ALL CAR MODELS

ITEM NO.	Neck(mm)	Length(mm)	MSRP
HG-04	70	700	
HG-05	77	700	
HG-06	63.5	700	



INTAKE SYSTEM



# AIR INTAKE SYSTEM

## PROJECT GOLF

INTAKE SYSTEM



Panel Filter (OV-017) Carbon Fiber Aero Form

ITEM NO.	DESCRIPTION	YEARS	MSRP
ZTSI-001	GOLF V 2.0 GTI	05-08	

ITEM NO.	DESCRIPTION	YEARS	MSRP
PC418A	NEW BETTLE 1.8L TURBO	02-on	
PC418B	GOLF IV 1.8T	98-03	
	AUDI A3 1.8T	97-03	
	SKODA OCTAVIA 1.8V	00-01	
PC419A	AUDI TT 1.8T 5V	00-07	
PT606	NEW BETTLE GOLFIV BORA 1.6	98-03	
PT607	POLO 1.4 16V	00-on	
	LUPO 1.4 16V	98-03	
PT608	NEW BETTLE 2.0	98-03	
PT609	GOLF IV / BORA2.0	98-03	

ITEM NO.	DESCRIPTION	YEARS	MSRP
PG420A	GOLF IV 2.0	98-03	
	BORA 2.0	98-03	
PG418A	NEW BETTLE 1.8T TURBO	02-04	
PG419A	AUDI TT 1.8T 5V	00-07	

ITEM NO.	DESCRIPTION	YEARS	MSRP
G-003	GOLF / JETTA III VR6, CORRADO	93-98	
	VR6 W / AIRPUMP		
G-004	GOLF / JETTA III 2.0L 8V	93-98	
G-005	VW GOLF / JETTA VR6 99(With H1-25)	99-02	
G-006	VW GOLF / JETTA 2.0 99(With H1-250)	99-02	



# AIR INTAKE SYSTEM

## SUPER INLET BIG (CARBON) TUBE

is specially designed CIVIC-series, effectively increasing the compressed air flow by its enlarged pipe.

Awesome top end power!

High density PE intake pipe



### CARBON

ITEM	DESCRIPTION	YEARS	MSRP
H-004BCF	CIVIC EG	92-95	
	CIVIC EK	96-97	

### EP

ITEM	DESCRIPTION	YEARS	MSRP
H-002F	CIVIC EG	92-95	
	CIVIC EK	96-97	

Equipped with Simota Urethane filter and high density PE intake pipe.

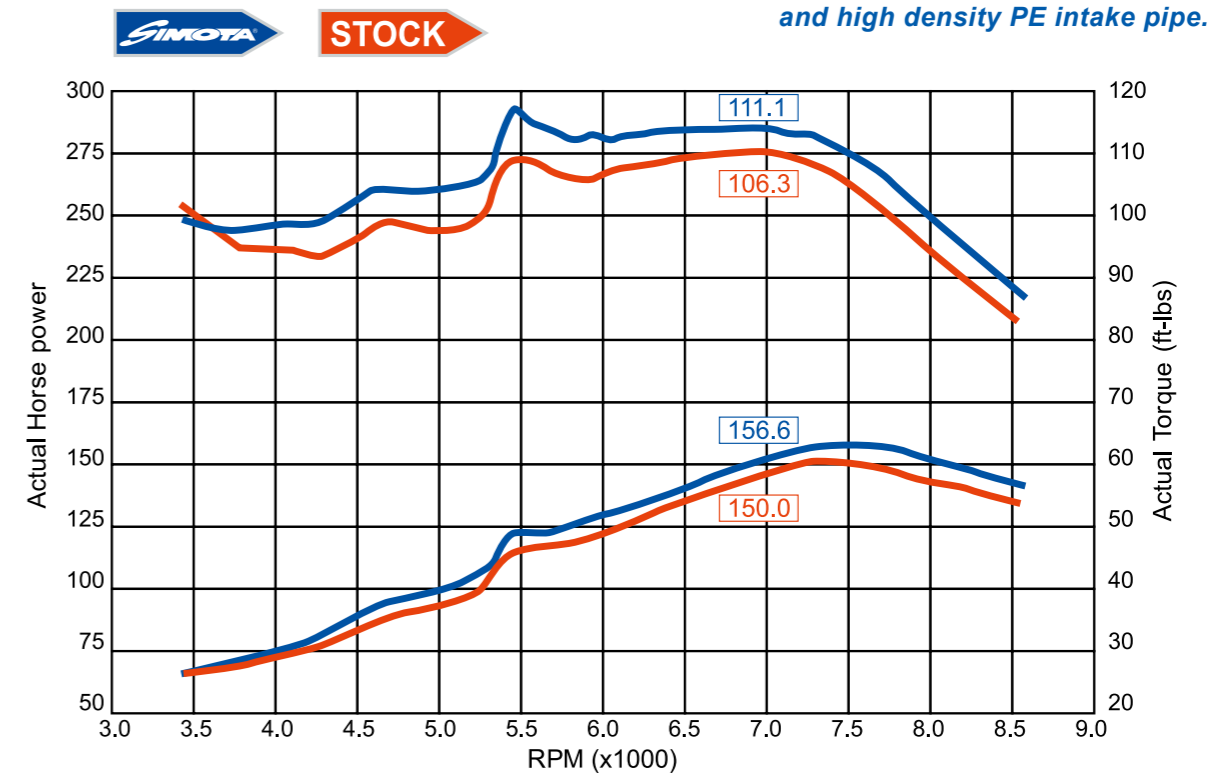

INTAKE SYSTEM





## COLD AIR INTAKE SYSTEMS

- 1 Available for the pipe inlets-65/70/77/80/85mm.
- 2 EGR valve design.
- 3 Designed by increasing volumetric efficiency.
- 4 Increases power and performance.
- 5 Inverted vector cone increases air flow to engine.
- 6 Easy to install.

### **DRAAGON**

Outer Diameter  $\varnothing$  65 / 70 / 77 / 80 / 85 mm



### **AIR STORM**

Outer Diameter  $\varnothing$  65 / 70 / 77 / 80 / 85 mm



## AERO FORM III

SIMOTA INNOVATIVE AERO FORM AIR INTAKE SYSTEM Engineered to replace the restrictive factory air box and piping, the Simota Aero Form Intake System feeds the engine with maximum air flow with filtration protection. Simply experience good torque at lower RPM range and almighty! top end horsepower at higher engine revving-with great sound The air vent collects denser cold air coming directly from outside, achieving idea air intake temperature with ram-effect induction.

### AERO FORM II

Base on our prestigious Aero Form Intake System, the enforced induction effect is strengthened by incorporating Simota's patented Twin Charger technology. Varied Length and Diameter of Piping with Venturi Effect.

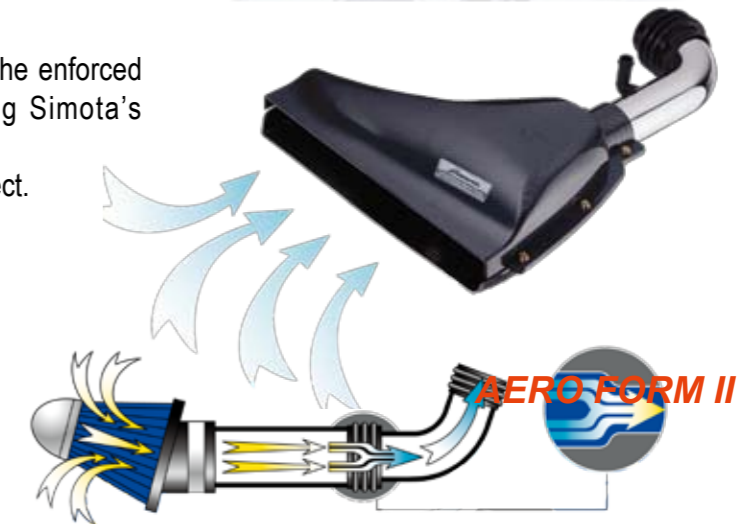

### AERO FORM II

ITEM NO.	DESCRIPTION(mm)	YEAR	MSRP
PTS-351	FORD MONDEO 2.0 16V	94-00	
PTS-352	FORD TIERRA 1.8	01-04	
	FORD TIERRA 2.0 RS	01-08	
	MAZDA PROTÉGÉ 1.8	99-03	
	MAZDA PREMACY 2.0	01-08	
PTS-353	FORD TIERRA 1.6 LS	01-04	
	MAZDA 323/ISAMU	01-04	
PTS-401	SUZUKI SOLIO 1.3 M13A	02-10	
PTS-402	SUZUKI SWIFT 1.5	05-10	
PTS-403	SUZUKI 1.3 (CHINA)	05-10	
PTS-404	SUZUKI SX4 1.6	06-10	
PTS-452	MITSUBISHI ECLIPSE NON TURBO 2.0	95-03	
PTS-453	MITSUBISHI LANCER FORTIS 2.0	07-10	
PTS-454	MITSUBISHI LANCER FORTIS 1.5	07-10	
PTS-501	RENAULT SCENIC 2.0	99-03	
PTS-551	OPEL ASTRA G 1.8	98-03	
	OPEL CORSA C 1.8	00-03	
	OPEL CORSA C 1.8 16V	00-06	
	OPEL CORSA II 1.8 16V	03-06	
PTS-552	OPEL CORSA B 1.4 8V	95-99	
PTS-553	OPEL TIGRA 1.4/1.6 16V	94-99	
	OPEL CORSA B 1.6 16V	93-00	
	OPEL CORSA B 1.4 16V	01-04	
PTS-558	OPEL ASTRA 1.6 8V	91-93	
PTS-559	OPEL CORSA C 1.2 L4 74BHP 12V	00-06	
PTS-603	CIROEN SAXO VTS/N7	97-93	
PTS-604	CIROEN C2 1.6L L4 16V DOHC VTR	03-10	
PTS-701	TOYOTA CORONA EXSIOR 2.0	93-97	
PTS-702	TOYOTA CAMRY 2.0	02-06	
PTS-703	TOYOTA CORONA PREMIO	97-01	
PTS-751	RENAULT CLIO 1.4	02-05	
PTS-752	RENAULT CLIO 2.0 RS	02-05	
PTS-801	VOLKSWAGEN GOLF V1.6 8V	03-08	
PTS-802	VOLKSWAGEN 1.6/1.8/1.8T(CHINA)		
PTS-803	VW NEW BEETLE/GOLF IV 1.6	98-03	
	AUDI A3 1.6	97-00	
PTS-804	VW POLO 1.4 16V	00-05	
	LUPO 1.4 16V	98-03	
PTS-805	VW NEW BEETLE 2.0	98-03	
PTS-806	VW GOLF IV / BORA 2.0	98-03	
PTS-901	CHRYSLER NEON 2.0	95-99	
PTS-951	HYUNDA/GETZ 1.5 16V	04-10	

### AERO FORM I

ITEM NO.	DESCRIPTION(mm)	YEAR	MSRP
PTS-001	NISSAN TIIDA/LATION 1.8	60-10	
PTS-002	NISSAN TIIDA 1.6 (CHINA)	60-10	
PTS-051	DAEWOO MATIZ 80CC	98-08	
PTS-101	HONDA CIVIC EG	92-95	
PTS-102	HONDA ACCORD(USA)	94-97	
PTS-103	HONDA CIVIC FERIO VTX/EX 1.7	01-05	
	HONDA EDIX 1.7	05-on	
PTS-104	HONDA ACCORD (TAIWAN)	94-97	
PTS-105	HONDA PRELUDE	92-96	
PTS-106	HONDA CRV (i-VTEC 2.0)	04-07	
PTS-107	HONDA CIVIC EX	96-00	
PTS-108	HONDA ACCORD (USA)	98-02	
PTS-109	HONDA ACCORD (TAIWAN)	98-02	
PTS-110	HONDA PRELUDE 2.0	97-99	
PTS-111	HONDA CIVIC Si 1.6	99-00	
PTS-112	HONDA CIVIC 2.0	06-10	
PTS-113	HONDA CIVIC 1.8	06-10	
PTS-151	PEUGEOT 206 1.4	99-on	
PTS-152	PEUGEOT 206 /307 1.6 16V	01-04	
PTS-153	PEUGEOT 106 S16 1.6 16V	97-99	
PTS-155	PEUGEOT 307 (SW) 2.0 16V	02-10	
PTS-201	ACURA INTEGRA LS/RS	94-99	
PTS-202	ACURA RSX 2.0 TYPE-S	01-05	
PTS-203	ACURA RSX 2.0 TYPE-S(w/o piping)	01-05	
	ACURA INTEGRA 2.0 TYPE-R (DC5)	01-05	
PTS-251	FIAT PANDA 1.3	03-08	
PTS-253	FITA PUNTO 1.4 Turbo	95-99	





## Top Speed

INTAKE SYSTEM

### CARBON CHARGER INTAKE SYSTEMS

are equipped with the patented Simota Twin Charger Technology, simply engineered to breathe like never before.

Features:

Boots horsepower and torque Improves engine's efficiency to increase 3-10 horsepower Minimal noise & heat-insulation 100% handmade.

The unique six-blade helical air-intake device inducts high-pressure airflow into the cylinders to enhance horsepower and fully utilizes gasoline. Double air induction enforces the air intake.



100% HANDE-MADE AND 100% CARBON FIBER  
ENHANCE HORSEPOWER UP TO 3-10 HP  
Custom / Made Simota Filter

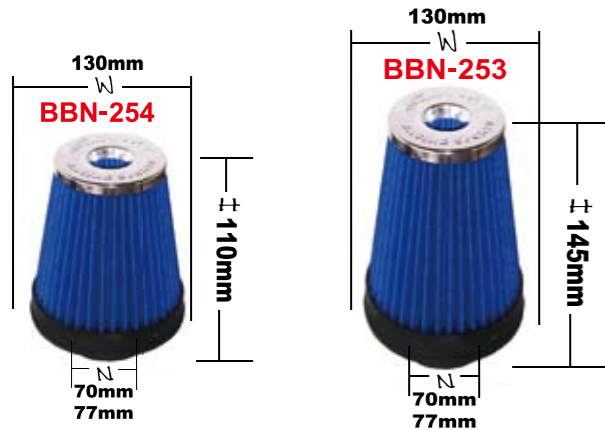

### BBN-253/254

NON-WOVEN FABRIC

ITEM NO.	WITH	HIGHT	NECK	MSRP
BBN-253-1	130	145	70	
BBN-254-1	130	110	70	
BBN-253-2	130	145	77	
BBN-254-2	130	110	77	

NON-WOVEN FABRIC

NON-WOVEN FABRIC

### FOR HYUNDAI



ITEM NO.	DESCRIPTION	YEAR	MSRP
CB-001	HYUNDAI MATRIX 1.6/1.8 16V	02-10	
CB-002	HYUNDAI GETZ 1.1 02-07/ 1.3 02-05 / 1.4	05-07	
CB-003	HYUNDAI COUPE 16V 2.0	02-08	
CB-004	HYUNDAI COUPE2.0	96-00	
CB-005	HYUNDAI TUCSON 2.0	05-10	
CB-006	HYUNDAI SANTA 2.7 V6	01-08	
CB-007	HYUNDAI ELANTRA 1.8	03-08	

### FOR VOLVO



ITEM NO.	DESCRIPTION	YEAR	MSRP
CB-051	VOLVO S60 2.0T	01-04	
CB-052	VOLVO S70 2.0	96-97	
CB-053	VOLVO S70 2.3 TURBO	99-00	
CB-054	VOLVO S80 3.0 T6	02-05	
CB-055	VOLVO S70 2.5 GLT	96-00	
CB-056	VOLVO 850 2.0T	93-99	
	VOLVO S70 2.0T	97-99	

### FOR HONDA



ITEM NO.	DESCRIPTION	YEAR	MSRP
CB-101	HONDA CIVIC EG 1.6 (K6) / DX EX LX	92-95	
CB-102	HONDA NEW CRV 2.0 (i-VTEC)	02-06	
	HONDA CIVIC TYPE R 2.0	01-06	
	ACURA RSX/TYPE-S 2.0	02-06	
CB-103	HONDA CIVIC 1.7 VTEC FERIO(K10) /DX LX	01-05	
CB-104	HONDA ACCORD 2.0 K7 (i-VTEC)(USA)	94-97	
	HONDA ACCORD 2.0 K9 (i-VTEC)	98-03	
CB-105	HONDA ACCORD 2.0 K7 (i-VTEC)(TAIWAN)	94-97	
	HONDA ACCORD 2.0 K9(i-VTEC)	98-03	
CB-107	HONDA CIVIC EK 1.6(K8)	96-00	
CB-108	HONDA ACCORD 2.0 DOHC I-VTEC 16V	03-07	
CB-109	HONDA FIT 1.3/1.4/1.5	05-10	
	CITY 1.5	05-10	
	JAZZ 1.3/1.4/1.5	05-07	
CB-110	HONDA CIVIC 2.0	06-10	
CB-111	HONDA CIVIC VIII 1.8	06~10	
CB-117	HONDA CIVIC SI 2.0	06-09	



### FOR NISSAN



ITEM NO.	DESCRIPTION	YEAR	MSRP
CB-201	NISSAN X-TRAIL 2.5	03-10	
CB-202	NISSAN 350Z V6 24V	03-06	
CB-203	NISSAN CEFIRO V6 2.0 (A33)	01-04	
CB-204	NISSAN MARCH 1.3 (Taiwan 99-on)	99-01	
	NISSAN MICRA 1.3	99-01	
CB-205	NISSAN TEANA 2.0/2.3/3.5 V6 (DOHC 24V)	04-10	
	NISSAN CEFIRO 2.0/2.3/3.5 V6 (DOHC 24V)	04-10	
CB-207	NISSAN MARCH 1.2,1.4	01-on	
CB-208	NISSAN INFINITI G35S 3.5	06-08	
CB-209	NISSAN TIIDA 1.6	05-10	
CB-210	NISSAN TIIDA 1.8	06-10	
CB-851	NISSAN SENTRA1.6 1.8 2.0	99-08	

INTAKE SYSTEM



# AIR INTAKE SYSTEM

INTAKE SYSTEM

CB-418 FORD FOCUS ST 2.5T



CB-502 PEUGEOT 206 1.6 16V



# AIR INTAKE SYSTEM

CB-562 OPEL ASTRA H 1.9 CDTI



CB-715 VOLKSWAGEN GOLF V 2.0 TDI



## FOR SUZUKI

ITEM NO.	DESCRIPTION	YEAR	MSRP
CB-251	SUZUKI SOLIO 1.3 (M13A)	02-10	
CB-252	SUZUKI GRAND VITARA 2.5 V6 DOHC 24V	99-07	
CB-253	SUZUKI SWIFT 1.5	05-10	
CB-255	SUZUKI SX4 1.6	06-10	
CB-257	SUZUKI JIMMY 1.3	01-09	
CB-258	SUZUKI JP 2.7	07-10	
CB-905	SUZUKI LIANA 1.6	04-10	
CB-908	SUZUKI SWIFT 1.5 (LEFT DRIVE)	05-10	

## FOR MITSUBISHI

ITEM NO.	DESCRIPTION	YEAR	MSRP
CB-352	MITSUBISHI LANCER 1.6	01-04	
CB-358	MITSUBISHI GALANT 2.0 V6	98-04	
CB-360	MITSUBISHI LANCER FORTIS 2.0	07-10	
CB-363	MITSUBISHI LANCER FORTIS 1.8	07-10	
CB-365	MITSUBISHI VIRAGE 1.8	01-04	

## FOR CITROEN

ITEM NO.	DESCRIPTION	YEAR	MSRP
CB-503	CITROEN PICASSO 2.0 16V	03-06	
CB-504	CITROEN N7/VTR 1.6	00-07	
CB-552	CORSA B 1.4 8V	94-99	
CB-601	CITROEN C3 1.4	03-10	
CB-602	CITROEN C3 1.6	02-10	
CB-603	CITROEN SAXO VTS 1.6 16V	97-03	
	N7	96-00	
CB-604	CITROEN C2 1.6L L4 16V DOHC VTR	03-10	
CB-605	CITROEN SAXO 1.4 L4 8V	97-03	

## FOR AUDI

ITEM NO.	DESCRIPTION	YEAR	MSRP
CB-711	AUDI A3 2.0T FSI	05-08	
CB-715	AUDI A3 2.0 TDI 16V	05-08	
CB-751	AUDI A4 1.8 5V	95-01	
CB-752	AUDI A4 1.8T (TURBO) 5V	95-01	
CB-753	AUDI A4 2.0 5V	01-08	
CB-754	AUDI A4 1.8T (TURBO) 5V	01-08	
CB-755	AUDI TT 1.8T 5V	00-07	

## FOR TOYOTA

ITEM NO.	DESCRIPTION	YEAR	MSRP
CB-301	TOYOTA COROLLA ALTIS 1.6/1.8 16V VVTi	01-07	
CB-302	TOYOTA VIOS 1.5 VVTi	02-10	
CB-303	TOYOTA COROLLA ALTIS 1.6/1.8 16V VVTi	01-07	
CB-304	TOYOTA CORONA EXSIOR 2.0	93-97	
CB-305	TOYOTA CAMRY 2.0	02-10	
CB-307	TOYOTA WISH 2.0 DOHC 16V	04-10	
CB-309	TOYOTA CORONA PREMIO 2.0	97-01	
CB-310	LEXUS IS200 2.0	99-05	
CB-311	TOYOTA AVANZA 1.3	05-10	
CB-312	TOYOTA YARIS 1.5	06-10	
	TOYOTA VIOS 1.5	07-10	
CB-314	TOYOTA YARIS 1.5 06-on	06-10	

## FOR MAZDA

ITEM NO.	DESCRIPTION	YEAR	MSRP
CB-402	MAZDA 323-ISAMU 1.6	00-03	
CB-411	MAZDA PROTÉGÉ 1.8	95-01	
	MAZDA PROTÉGÉ 2.0	01-03	
	MAZDA PREMACY 2.0	01-08	
CB-415	MAZDA TRIBUTE 2.3 DOHC 16V	04-10	
CB-651	MAZDA 3 2.0/2.3	04-10	
	MAZDA 5 2.0	06-10	
CB-652	MAZDA 6 2.0/2.3	02-07	
CB-653	MAZDA TRIBUTE V6 3.0 DOHC 24V	01-10	
CB-654	MAZDA 3 1.6 L4 16V DOHC	04-10	
CB-655	MAZDA RX-8 1.3L	03-10	

## FOR OPEL

ITEM NO.	DESCRIPTION	YEAR	MSRP
CB-552	OPEL TIGRA 1.4 8V	94-00	
CB-553	OPEL CORSA B/ TIGRA 1.4/1.6 16V	94-00	
CB-555	OPEL CORSA II 1.4		
CB-558	OPEL ASTRA 1.6 8V	91-93	
CB-560	OPEL VECTRA B 2.0 L4 16V	95-00	
CB-562	OPEL ASTRA H 1.9 CDTI	04-10	
CB-900	OPEL ASTRAG 1.8	98-03	
CB-901	OPEL CORSA C 1.4	00-06	
CB-902	OPEL CORSA C 1.2L L4 74BHP 12V	00-06	
CB-903	OPEL CORSA C 1.8 DOHC L4 16V	01-06	
CB-906	OPEL ASTRA H GTC 2.0T	05-10	
CB-907	OPEL ASTRA H 1.8	05-10	

## FOR RENAULT

ITEM NO.	DESCRIPTION	YEAR	MSRP
CB-801	RENAULT CLIO RS 2.0 16V	01-05	
CB-803	RENAULT CLIO 1.4 16V	01-05	
CB-804	RENAULT MEGANE II 1.6/2.0	03-on	
CB-805	RENAULT SCENIC 1.6/2.0	99-on	

## FOR SAAB

ITEM NO.	DESCRIPTION	YEAR	MSRP
CB-802	SAAB 9-3 2.0 L4 TURBO	03-10	
CB-806	SAAB 900 2.0T	94-98	
CB-807	SAAB 9-5 2.0T	01-05	
CB-808	SAAB 9000 2.3T	93-97	

## FOR FORD

ITEM NO.	DESCRIPTION	YEAR	MSRP
CB-401	FORD FOCUS 1.6	99-04	
CB-402	FORD TIERRA/LIFE 1.6	00-04	
CB-403	FORD FOCUS 2.0 L4 DOHC 16V	98-04	
CB-404	FORD FOCUS ST-170 2.0	02-04	
CB-405	FORD METROSTAR 2.0	00-08	
CB-406	FORD MONDEO 2.0 16V	94-00	
CB-408	FORD FOCUS 1.6	05-08	
CB-409	FORD FOCUS 1.8 2.0	04-10	
CB-410	FORD FOCUS RS 2.0T	02-04	
CB-411	FORD TIERRA RS 1.8/2.0	02-08	
	FORD MAV 2.0	02-07	
CB-412	FORD ESCAPE 2.0/MAZDA TRIBUTE 2.0	01-03	
CB-413	FORD MONDEO METROSTAR 2.5 V6 RS	02-08	
CB-414	FORD LIATA 1.6 95-99/MAZDA 323 1.6	95-99	
CB-415	FORD ESCAPE 2.3	03-10	
CB-416	FORD FIESTA ST150 2.0 16V	05-08	
CB-417	FORD FIESTA 1.6 DOHC 16V	05-08	
CB-418	FORD FOCUS ST 2.5T	05-08	
CB-653	FORD ESCAPE V6 3.0 DOHC 24V	01-10	

## FOR FIAT

ITEM NO.	DESCRIPTION	YEAR	MSRP
CB-451	FIAT PUNTO 1.4 GT TURBO	94-99	
CB-452	FIAT PUNTO 1.2 8V	94-99	
CB-453	FIAT PUNTO 1.2 16V	99-04	
CB-454	FIAT PUNTO HGT 1.8 16V	99-04	

## FOR PEUGEOT

ITEM NO.	DESCRIPTION	YEAR	MSRP
CB-501	PEUGEOT 206 1.4 8V	98-06	
CB-502	PEUGEOT 206 1.6 16V	06-10	
CB-503	PEUGEOT 206 S16/307 2.0 16V	03-05	
	PEUGEOT 307 2.0 16V	01-05	
CB-504	PEUGEOT 307 1.6	01-04	
CB-505	PEUGEOT 206 RC 2.0 16V	03-05	
CB-507	PEUGEOT 206 1.6	98-05	
	PEUGEOT 106 16V	97-99	

## FOR VOLKSWAGEN

ITEM NO.	DESCRIPTION	YEAR	MSRP
CB-701	VOLKSWAGEN GOLF IV 1.8T	97-03	
	SKODA OCTAVIA 1.8T	97-04	
CB-702	VOLKSWAGEN NEW BEETLE 1.8T 20V	02-08	
CB-703	VOLKSWAGEN LUPO/POLO 1.4 16V	00-05	
	SEAT IBIZA 1.4 16V	00-05	
CB-704	VOLKSWAGEN NEW BEETLE 2.0	98-05	
CB-705	VOLKSWAGEN NEW BEETLE 1.6	01-07	
CB-706	VOLKSWAGEN GOLF V 1.6 8V	03-07	
CB-707	VOLKSWAGEN GOLF V 1.6 16V (FSI)	03-08	
CB-708	VOLKSWAGEN GOLF IV 1.6/ BORA 1.6	97-03	
	L4 SHOC 8V		
CB-709	VOLKSWAGEN GOLF V 2.0 16V (FSI)	04-08	
CB-710	VOLKSWAGEN VENTO 1.8 CL/GL/GT	92-97	
	GOLF III 1.8	92-97	
CB-711	VOLKSWAGEN GOLF GTI 2.0 FSI (TURBO)	04-08	
CB-712	VOLKSWAGEN GOLF V 1.9 (TDI)	05-08	
CB-713	VOLKSWAGEN POINTER 1.8	05-08	
CB-714	VOLKSWAGEN GOLF IV 1.4 16V	98-04	
CB-715	VOLKSWAGEN PASSAT 2.0/GOLF 2.0 (TDI)	05-08	
CB-716	VOLKSWAGEN GOLF V 1.4 GT TSI	06-08	

## FOR MINI

ITEM NO.	DESCRIPTION	YEAR	MSRP
CB-852	MINI COOPER S 1.6 L4	03-06	

## FOR DAIHATSU

ITEM NO.	DESCRIPTION	YEAR	MSRP
CB-853	DAIHATSU TERIOS 1.3	04-08	
CB-857	DAIHATSU SIRION 1.3 DVVT	05-10	

## FOR KIA

ITEM NO.	DESCRIPTION	YEAR	MSRP
CB-854	KIA EURO STAR/PICANTO 1.1	05-09	

## FOR CHEVROLET

ITEM NO.	DESCRIPTION	YEAR	MSRP
CB-855	CHEVROLET AVEO 1.4, 1.5	00-10	
CB-856	CHEVROLET OPTRA 1.6	03-05	

INTAKE SYSTEM



# AIR INTAKE SYSTEM

## SHARK

Shark carbon fiber intake systems are SIMOTA newest revolution air Special design for volume more air, also replacing the air filter to get entire air path to the engine. It's very unique design and got the best result.

Dry carbon kit, 100% by handmade particular surface.



By replacing the air filter to get entire air path to the engine.

Special inside space volume for more air storage space, enhance torque power and horse power in best function.

By high quality silicone with 4 layer of reinforcement nonwoven. It is durable, anti-heat, anti-oil, anti-expansion, and anti-pressure

### FOR HYUNDAI

ITEM NO.	DESCRIPTION	YEAR	MSRP
CBII-002	HYUNDAI GETZ 1.1	02-07	
	HYUNDAI GETZ 1.3	02-05	
	HYUNDAI GETZ 1.4	05-07	
CBII-008	HYUNDAI VERNA 1.6	06-10	

### FOR SUZUKI

ITEM NO.	DESCRIPTION	YEAR	MSRP
CBII-253	SUZUKI SWIFT 1.5	05-10	
CBII-255	SUZUKI SX4 1.6	06-10	
CBII-256	SUZUKI SWIFT 1.3(China)	05-10	
CBII-259	SUZUKI SX4 1.6	09-10	

### FOR HONDA

ITEM NO.	DESCRIPTION	YEAR	MSRP
CBII-101	HONDA CIVIC 1.6 EG	92-95	
CBII-102	HONDA NEW CRV 2.0 (i-VTEC)	02-06	
	TYPE R 2.0	01-06	
	ACURA RSX/TYPE-S 2.0	02-06	
CBII-104	HONDA ACCORD 2.0 K7	94-97	
	HONDA ACCORD 2.0 K9	98-03	
CBII-105	HONDA ACCORD 2.0 K7	94-97	
	HONDA ACCORD 2.0 K9	98-03	
	HONDA ACCORD 2.0 K9	98-03	
CBII-107	HONDA CIVIC 1.6 EG	96-00	
CBII-108	HONDA ACCORD 2.0 I-VTEC	03-07	
CBII-110	HONDA CIVIC VIII 2.0	06-10	
CBII-111	HONDA CIVIC VIII 1.8	06-10	
CBII-113	HONDA CRV 2.4	08-10	
CBII-114	HONDA CRV 2.0	08-10	
CBII-115	HONDA FIT 1.3 1.5	08-10	
	HONDA CITY 1.3 1.5	08-10	
CBII-116	HONDA ACCORD 2.4	08-10	

### FOR NISSAN

ITEM NO.	DESCRIPTION	YEAR	MSRP
CBII-209	NISSAN TIIDA 1.8	06-10	
	NISSAN BLUEBIRD 2.0	07-10	
CBII-210	NISSAN TIIDA 1.6	05-10	
CBII-211	NISSAN TEANA 2.0 / CEFIRO 2.0	05-10	
CBII-851	NISSAN SENTRA 1.6/1.8/2.0	99-08	

### FOR TOYOTA

ITEM NO.	DESCRIPTION	YEAR	MSRP
CBII-301	TOYOTA ALTIS 1.6-1.8 DOHC 16V	01-07	
CBII-302	TOYOTA VIOS 1.5 (Taiwan)	02-10	
CBII-305	TOYOTA CAMRY 2.0 16V	02-05	
CBII-307	TOYOTA WISH 2.0 DOHC 16V	04-10	
CBII-312	TOYOTA YARIS 1.5	06-10	
	TOYOTA VIOS 1.5	07-10	
CBII-315	TOYOTA RAV4 2.4	08-10	
CBII-316	TOYOTA RUSH 1.5	08-10	
CBII-317	TOYOTA LEXUS 2.5	06-10	
	MARK-X 2.5(China)	05-10	
CBII-318	TOYOTA YARIS 1.6 (China)	08-10	
CBII-319	TOYOTA INNOVA 2.7	07-09	

### FOR MITSUBISHI

ITEM NO.	DESCRIPTION	YEAR	MSRP
CBII-352	MITSUBISHI LANCER 1.6	01-04	
CBII-360	MITSUBISHI LANCER FORTIS 2.0	07-10	
CBII-361	MITSUBISHI LANCER FORTIS 1.5	07-10	
CBII-362	MITSUBISHI COLT PLUS 1.5	06-10	
CBII-363	MITSUBISHI LANCER FORTIS 1.8	07-10	
CBII-364	MITSUBISHI OUTLANDER 3.0	08-10	

# AIR INTAKE SYSTEM

**+10.2 HP**

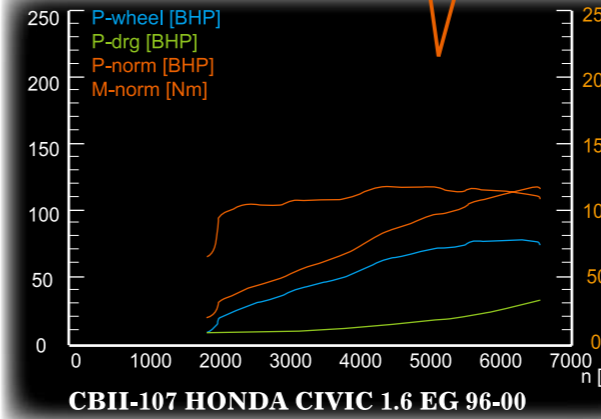

### FOR FORD

ITEM NO.	DESCRIPTION	YEAR	MSRP
CBII-404	FORD FOCUS 2.0 ST-170	02-04	
CBII-409	FORD FOCUS 1.8/2.0	04-10	
CBII-411	FORD TIERRA RS 1.8/2.0	02-08	
	FORD MAV 2.0	02-07	
CBII-412	FORD ESCAPE 2.0 /	01-03	
CBII-420	FORD FOCUS TDCI 2.0	07-10	

### FOR AUDI

ITEM NO.	DESCRIPTION	YEAR	MSRP
CBII-711	AUDI A3 2.0T FSI	05-08	
CBII-717	AUDI A3 2.0 TDI	05-08	
CBII-754	AUDI A4 1.8/2.0T	01-08	
CBII-755	AUDI TT 1.8T 5V (TURBO)	00-07	

### FOR MAZDA

ITEM NO.	DESCRIPTION	YEAR	MSRP
CBII-411	MAZDA PROTEGE 2.0	01-03	
	MAZDA PROTEGE 1.8	95-01	
	MAZDA PREMACY 2.0	01-08	
CBII-412	MAZDA TRIBUTE 2.0	01-03	
CBII-651	MAZDA 3 2.0/2.3	04-10	
	MAZDA 5 2.0	06-10	
CBII-652	MAZDA 6 2.0-2.3	02-07	
CBII-654	MAZDA M3 1.6	04-10	
CBII-656	MAZDA 6 2.5	08-10	

### FOR SAAB

ITEM NO.	DESCRIPTION	YEAR	MSRP
CBII-802	SAAB 9-3 2.0 L4 TURBO	03-10	

### FOR KIA

ITEM NO.	DESCRIPTION	YEAR	MSRP
CBII-858	KIA CERATO 1.6	08-10	

### FOR ALFA

ITEM NO.	DESCRIPTION	YEAR	MSRP
CBII-910	ALFA ROMEO 147 1.6/2.1 TS	01-on	

### FOR PEUGEOT

ITEM NO.	DESCRIPTION	YEAR	MSRP
CBII-501	PEUGEOT 206 1.4 8V	98-06	
CBII-507	PEUGEOT 206 1.6	98-05	
CBII-508	PEUGEOT 207 1.6T	08-10	
CBII-606	PEUGEOT 307 1.6	06-10	

### FOR SUBARU

ITEM NO.	DESCRIPTION	YEAR	MSRP
CBII-911	SUBARU IMPREZA 1.5	08-10	

### FOR CITROEN

ITEM NO.	DESCRIPTION	YEAR	MSRP
CBII-604	CITROEN C2 1.6L VTR	03-10	
CBII-606	CITROEN C4 1.6L VTR	05-10	

### FOR PEROUDA

ITEM NO.	DESCRIPTION	YEAR	MSRP
CBII-912	PEROUDA MYVI 1.3	05-10	

### FOR VOLKSWAGEN

ITEM NO.	DESCRIPTION	YEAR	MSRP
CBII-706	VOLKSWAGEN GOLF V 1.6 8V	03-07	
CBII-711	VOLKSWAGEN GOLF V GTI 2.0 FSI (TURBO)	04-08	
CBII-712	VOLKSWAGEN GOLF V 1.9 TDI	05-08	
CBII-715	VOLKSWAGEN GOLF V 2.0 TDI	05-08	
	VOLKSWAGEN PASSAT 2.0 TDI	07-08	
	VOLKSWAGEN JETTA 2.0 TDI	07-08	

### FOR PROTON

ITEM NO.	DESCRIPTION	YEAR	MSRP
CBII-913	PROTON SAGA 1.3	08-10	

### FOR BMW

ITEM NO.	DESCRIPTION	YEAR	MSRP
CBII-914	BMW E90 330	05-10	







## CARBON FIBER AERO FORM INTAKE SYSTEM

Our advanced aero form air intake system is 100% Carbon fiber intake kit is all 100% handmade. With Simota's Carbon fiber aero form air intake system, the horsepower increases more than 5~12 hp dramatically

**Features:**

- ▶ Boost horsepower and torque
- ▶ Improves engine's efficiency
- ▶ Heat insulation & forced induction to generates more external cold air
- ▶ Lighter and Stronger
- ▶ 100% handmade
- ▶ Prevents engine to accumulate the carbon jams effectively, therefore the gasoline fully utilizes and creates the maximum performance.



### FOR BMW

ITEM NO.	DESCRIPTION	YEAR	MSRP
CF610-01	BMW E36 318i (1.9L) M44	96-98	
CF610-02	BMW E36 325i (USA) M50	92-95	
CF610-03	BMW E36 328 /Europe E36 325 M52	96-99	
CF610-04	BMW E46-320-323-325-328 M52	99-03	
CF610-05	BMW E46 318 M43	99-03	
CF610-06	BMW E46 330i M54	01-03	
	E36 S50 M3 286hp	91-99	
CF610-07	BMW E30 318 M40	83-95	
CF610-08	BMW E36 318i(1.8L) M42	92-95	
CF610-14	BMW X5 3.0 L6 M54 24V	01-on	
CF610-15	BMW E46 318 (2.0L) M44	01-05	
CF610-16	BMW 525 2.5L L6(E34) 24V M50 (Europe Model)	90-96	
CF610-17	BMW E34 530i (3.0L) M60	93-95	
CF610-18	BMW E39 520 2.0 M52 98-03		
CF610-19	BMW E39 528 2.8L L6 M52	98-00	
CF610-20	BMW E46 M3 3.2L(S54)	01-on	
CF610-22	BMW E34 M5 3.5L 88-95		
CF610-23	BMW E90 320i	05-10	
CF610-24	BMW E60 M5 5.0	05-10	
CF610-25	BMW Z3 M COUPE (S52)	98-02	
CF610-26	BMW E60 520i/523i/525i	03-10	
CF610-27	BMW E90 330 / 325	05-10	
CF610-28	BMW Z3 1.9L L4 140HP	96-99	
CF610-29	BMW 335i 306PS N54	06-10	
CF610-30	BMW E87 130i(UF30)	05-10	



### FOR SUBARU

ITEM NO.	DESCRIPTION	YEAR	MSRP
CF615-01	RENAULT CLIO RS 2.0 16V	01-05	
CF615-02	SUBARU IMPREZA GT (GC8) 2.0T (TAIWAN)	97-98	
	SUBARU IMPREZA (GC8) 2.0T (WORLD)	93-97	
CF615-04	SUBARU IMPREZA GT 2.0T	99-01	
CF615-06	SUBARU FORESTER 2.0	04-08	
CF615-07	SUBARU IMPREZA WRX/STI 2.0T	02-on	
	SUBARU IMPREZA WRX/STI 2.5T	05-on	
CF615-08	SUBARU IMPREZA 1.5	08-10	





# AIR INTAKE SYSTEM

INTAKE SYSTEM

## FOR HONDA

ITEM NO.	DESCRIPTION	YEAR	MSRP
CF620-02	HONDA ACCORD 2.0	03-08	
CF620-03	HONDA ACCORD 3.0 (i-VTEC)	03-08	
CF620-04	HONDA CIVIC CR-V 2.0	02-06	
	HONDA CIVIC TYPE-R 2.0	01-06	
	ACURA RSX TYPE-S 2.0L	02-06	
CF620-05	HONDA ACCORD (K7) VTEC	94-97	
	ACCORD 2.0 K9	98-03	
CF620-06	HONDA CIVIC EG (K6) 1.6	92-95	
CF620-07	HONDA CIVIC EK (K8) 1.6	96-00	
CF620-08	HONDA JAZZ/CITY/FIT 1.5	05-07	
	HONDA FIT 1.3	05-07	
CF620-09	HONDA CIVIC 1.8	06-10	
CF620-10	HONDA CIVIC VIII 2.0	06-10	
CF620-11	HONDA CIVIC SI 2.0	06-10	
CF620-12	HONDA CRV 2.4	08-10	
CF620-13	HONDA ACCORD 2.4	08-10	
CF620-14	HONDA FIT 1.3/1.5	08-10	
	HONDA CITY 1.5	08-10	
CF620-15	HONDA CIVIC 2.0	05-09	

## FOR MAZDA

ITEM NO.	DESCRIPTION	YEAR	MSRP
CF625-01	MAZDA 3 2.0/2.3	04-10	
	MAZDA 5 2.0	06-10	
CF625-02	MAZDA 6 2.0/2.3	02-07	
CF625-03	MAZDA 3 1.6 16V L4	04-10	
CF625-05	MAZDA RX-8 1.3L	03-10	
CF625-06	MAZDA MX-5 1.6/1.8 L4 16	01-05	
CF625-07	MAZDA 6 2.5	08-10	
CF625-08	MAZDA 2 1.5	08-10	
CF640-03	MAZDA TRIBUTE 2.0	01-04	
CF640-04	MAZDA TRIBUTE 2.3 DOHC 16V	04-10	
CF640-05	MAZDA TRIBUTE 3.0 V6 DOHC 24V	01-10	
CF640-06	MAZDA PREMACY 2.0	01-08	
	MAZDA PROTAGE 1.8/2.0	95-01	
CF640-07	MAZDA 323 1.6 DOHC 16V	00-03	
	MAZDA ISAMU 1.6 DOHC 16V	00-03	

## FOR FORD

ITEM NO.	DESCRIPTION	YEAR	MSRP
CF625-08	FORD NEW FITESTA 1.5	09-10	
CF640-02	FORD FOCUS 1.8 / 2.0	04-10	
CF640-03	FORD ESCAPE 2.0 DOHC 16V	01-04	
CF640-04	FORD ESCAPE 2.3 DOHC 16V	04-10	
CF640-05	FORD ESCAPE 3.0 V6 DOHC 24V	01-10	
CF640-06	FORD TIERRA 1.8/2.0	02-04	
	FORD MAV 2.0	02-07	
CF640-07	FORD TIERRA/LIFE 1.6	00-04	
CF640-08	FORD METROSTAR 2.0	00-08	

## FOR VAUXHALL

ITEM NO.	DESCRIPTION	YEAR	MSRP
CF635-01	VAUXHALL VX220 TURBO 2.0T	00-on	

## FOR MITSUBISHI

ITEM NO.	DESCRIPTION	YEAR	MSRP
CF630-01	MITSUBISHI Lancer 1.6	01-04	
CF630-02	MITSUBISHI VIRAGE 1.8	01-04	
CF630-03	MITSUBISHI OUTLANDER 2.4	03-07	
CF630-04	MITSUBISHI LANCER 1.6	96-00	
	MITSUBISHI VIRAGE 1.8	96-00	
CF630-05	MITSUBISHI EVO 7 8 9generation	02-07	
CF630-06	MITSUBISHI EVO7 8 9generation	02-07	
CF630-07	MITSUBISHI LANCER FORTIS 2.0	07-10	
CF630-08	MITSUBISHI LANCER FORTIS 1.5	07-10	
CF630-09	MITSUBISHI LANCER FORTIS 1.8	07-10	

## FOR VOLVO

ITEM NO.	DESCRIPTION	YEAR	MSRP
CF645-01	VOLVO S60 2.0T	01-04	
CF645-02	VOLVO 850 2.3T	96-99	
CF645-03	VOLVO XC90 2.5T (TURBO)	05-10	

## FOR TOYOTA

ITEM NO.	DESCRIPTION	YEAR	MSRP
CF650-01	TOYOTA COROLLA ALTIS 1.6 L4 16V	01-08	
	TOYOTA COROLLA ALTIS 1.8 L4 16V		
CF650-02	TOYOTA WISH 2.0 L4 DOHC 16V	04-10	
CF650-03	TOYOTA VIOS 1.5 VVT-I	02-10	
CF650-06	TOYOTA YARIS 1.5	06-10	
	TOYOTA VIOS 1.5	07-10	
CF650-07	TOYOTA LEXUS 2.5 (CHINA)	06-on	
CF650-09	TOYOTA CAMRY 2.0	06-on	

## FOR VOLVO

ITEM NO.	DESCRIPTION	YEAR	MSRP
CF650-04	LEXUS IS300 3.0 L6	01-05	
CF650-05	LEXUS GS300 3.0	06-08	
CF650-08	LEXUS IS250 2.5	06-10	

## FOR BENZ

ITEM NO.	DESCRIPTION	YEAR	MSRP
CF655-01	BENZ W202 C200 (M111)	93~00	
CF655-02	BENZ W210 E200/E230	95-02	
CF655-03	BENZ W210 E240/E280/E320	99-02	

## FOR SKODA

ITEM NO.	DESCRIPTION	YEAR	MSRP
CF660-02	SKODA OCTAVIA 1.8T	97-04	

## FOR SUZUKI

ITEM NO.	DESCRIPTION	YEAR	MSRP
CF685-01	SUZUKI GRAND VITARA 2.5 V6 DOHC 24V	99-07	

# AIR INTAKE SYSTEM

## SIMOTA +10.3HP

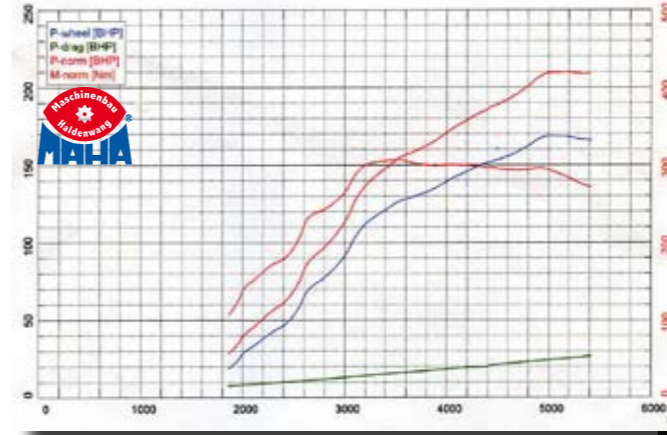

CF660-24 VOLKSWAGEN GOLF V 2.0 GTI 05-0N

## FOR VOLKSWAGEN

ITEM NO.	DESCRIPTION	YEAR	MSRP
CF660-01	VOLKSWAGEN GOLF IV 1.6	97-04	
	VOLKSWAGEN BETTLE 1.6	98-07	
	VOLKSWAGEN BORA 1.6	98-04	
CF660-02	VOLKSWAGEN GOLF IV 1.8T	97-03	
	VOLKSWAGEN BORA 1.8T/2.0	97-04	
	VOLKSWAGEN BETTLE 1.8T	98-08	
CF660-04	VOLKSWAGEN GOLF III (VR6) 2.8	92-99	
	VOLKSWAGEN GOLF III (VR6) 2.9		
CF660-05	VOLKSWAGEN GOLF IV 2.3 5V	00-04	
	VOLKSWAGEN GOLF IV R32 3.2	02-04	
CF660-06	VOLKSWAGEN GOLF V 1.6 8V	03-07	
CF660-07	VOLKSWAGEN GOLF V 2.0 16V FSI	05-08	
CF660-12	VOLKSWAGEN GOLF V 1.6 16V FSI	03-08	
CF660-13	VOLKSWAGEN GOLF IV 2.0	98-04	
	VOLKSWAGEN BORA 2.0	98-04	
	VOLKSWAGEN BETTLE 2.0	98-05	
CF660-14	VOLKSWAGEN TOURAN 1.9 TDI	03-07	
CF660-15	VOLKSWAGEN GOLF IV 1.4 16V	98-04	
CF660-18	VOLKSWAGEN GOLF V 1.9 TDI	05-08	
CF660-19	VOLKSWAGEN GOLF V 2.0 TDI	05-08	
CF660-20	VOLKSWAGEN GOLF V 1.4 GT TSI	06-08	
CF660-22	VOLKSWAGEN PASSAT 2.0 TDI	05-08	
CF660-24	VOLKSWAGEN GOLF V 2.0 GTI	04-on	

## FOR AUDI

ITEM NO.	DESCRIPTION	YEAR	MSRP
CF660-01	AUDI A3 1.6	97-04	
CF660-02	AUDI A3 1.8T	96-03	
	AUDI TT 180 BHP	98-07	
CF660-05	AUDI TT 1.8T 215HP (QUATTRO)	99-06	
CF661-01	AUDI S3 1.8T (TURBO)	99-on	
CF661-02	AUDI A4 1.8 5V	95-01	
CF661-03	AUDI A4 1.8T 8E	05-08	
CF661-04	AUDI A4 2.0T FSI	06-08	
CF661-05	AUDI A3 2.0 TDI 16V	05-08	
CF661-06	AUDI A3 2.0T FSI	05-08	
CF661-07	AUDI Q7 3.0 TDI	07-10	

## FOR NISSAN

ITEM NO.	DESCRIPTION	YEAR	MSRP
CF670-01	NISSAN 350Z V6 24V	03-06	
CF670-02	INFINITI FX35 3.5	03-08	
CF670-03	INFINITI G35 3.5	03-08	
CF670-04	NISSAN SENTRA 1.6/1.8/2.0 DOHC 16V	99-04	
	NISSAN SUNNY 1.6/1.8/2.0 DOHC 16V	99-04	
CF670-05	NISSAN CEFIRO 2.0 V6 24V	96-01	
CF670-06	NISSAN TEANA 2.0/2.3/3.5 V6 DOHC 24V	04-10	
	NISSAN CEFIRO 2.0/2.3/3.5 V6 DOHC 24V	04-10	
CF670-07	NISSAN SETRA M1 1.6/1.8/2.0 DOHC 16V	04-08	

## FOR HYUNDAI

ITEM NO.	DESCRIPTION	YEAR	MSRP
CF680-01	HYUNDAI TUCSON 2.0 2WD DOHC 16V L4	05-10	
CF680-02	HYUNDAI GETZ 1.1	02-07	
	HYUNDAI GETZ 1.3	02-05	
	HYUNDAI GETZ 1.4	05-07	
CF680-03	HYUNDAI MATRIX 1.6/1.8 DOHC 16V	02-10	
CF680-04	HYUNDAI TUCSON 2.0 VG TURBO	06-10	

## FOR PEUGEOT

ITEM NO.	DESCRIPTION	YEAR	MSRP
CF690-01	PEUGEOT 206 RC 2.0 L4 DOHC 16V	03-05	
CF690-02	PEUGEOT 206 1.4	99-06	
CF690-03	PEUGEOT 307 1.6	01-04	
CF690-04	PEUGEOT 307 2.0 16V	01-05	
CF690-06	PEUGEOT 206 1.6	98-05	

## FOR CITROEN

ITEM NO.	DESCRIPTION	YEAR	MSRP
CF690-03	CITROEN N7/VTR 1.6 00-07	99-06	
CF690-04	CITROEN PICASSO 2.0 16V	03-06	

## For MINI

ITEM NO.	DESCRIPTION	YEAR	MSRP
CF695-1	MINI COOPERS 1.6T(R53)	01-07	
CF695-2	MINI COOPERS 1.6T(R56)	07-09	

INTAKE SYSTEM





# AIR INTAKE SYSTEM

## STANDARD AIR INTAKE SYSTEM

SIMOTA STANDSRD AIR INTAKE SYSTEM

is designed for perfect fit and trouble-free installation. By installing Simota high performance air intake kits, you definitely gain better air flow rate and greater horsepower.



INTAKE SYSTEM

ITEM NO.	DESCRIPTION	YEARS	MSRP
<b>BMW</b>			
B-001	BMW E46 323/328	98-04	
B-004	BMW E46 330	00-04	
<b>CHRYSLER</b>			
C-001	CHRYSLER PT CRUISER 2.4L 4CY DOHC 16V		
CH-001	CHEVY CORVETTE 5.7L V8	97-00	
CH-002	CHEVY CORVETTE 5.7L V8	01-03	
<b>DAEWOO</b>			
DF-001	DAEWOO MATIZ 0.8	01-03	
<b>HONDA</b>			
DH-002	HONDA CIVIC	92-95	
DH-003	HONDA NEW CIVIC	96-98	
<b>FORD</b>			
F-005	FORD PROBE (4CY)	93-96	
F-006	FORD TIERA 1.6	99-on	
F-006-1	FORD FOCUS SOHC/MFI(L24)	99-04	
F-006-2	FORD FOCUS DOHC	99	
F-011	FORD EXPLORER V6 4.0	02-on	
<b>VOLKSEAGEN</b>			
G-003	VW GOLF/JETTA VR6/CORRADO VR6		
G-004	VW GOLF 93/JETTA III 2.0L 8V		
G-005	VW GOLF /JETTA 99 VR6		
G-006	VW GOLF /JETTA 99 2.0L		
<b>HONDA</b>			
H-001/ H-013	HONDA CIVIC/CRX SI	88-91	
H-002/ H-009A	HONDA CIVIC EG/VTEC	92-95	
H-002F	HONDA CIVIC EG	92-95	
H-003/ H-009B	HONDA NEW CIVIC EK/CIVIC VTEC	96-97	
H-003F	HONDA NEW CIVIC EK	96-00	
H-004	HONDA ACCORD	90-93	

ITEM NO.	DESCRIPTION	YEARS	MSRP
H-006/ H-015	HONDA NEW ACCORD 4CY 98/ACURA 2.2 CL	97-98	
H-006B	HONDA NEW ACCORD 4CY	98-02	
H-006C	HONDA ACCORD V6	98-02	
H-008	ACURA INTEGRA	90-93	
H-008A	ACURA INTEGRA (LS/RS)	94-01	
H-008B	ACURA INTEGRA (GSR)	94-97	
H-010	HONDA CITY 1.5	92-96	
H-011	HONDA PRELUDE	92-96	
H-012	HONDA CIVIC CARBURETOR	88-91	
H-014	HONDA CIVIC DX	96-98	
H-015	HONDA 2.2 CL	97-01	
H-016	HONDA PRELUDE 2.0	92-01	
H-018	HONDA CIVIC SI	99-00	
H-019	HONDA CIVIC DX/LX/CX	88-91	
H-020	HONDA CIVIC FERIO VTX/ES 1.7 01		
H-021	ACURA RSX TYPE-S 2002		
H-022	ACURA RSX 2002		
H-023	HONDA CRV 2.0	02-04	
H-024	HONDA CITY	96-00	
H-025	HONDA FIT 1.3/1.4/1.5 05-on, CITY 1.5 05-ON JAZZ 1.3/1.4/1.5	05-07	
H-026	HONDA CIVIC 1.8	06-10	
H-027	HONDA RAFAGA	93-95	
H-028	HONDA JAZZ/CITY/FIT 1.5	05-10	
H-031	HONDA CIVIC 2.0	06-10	
H-032	HONDA FIT 1.3/1.5 05-on, JAZZ 1.3/1.5	08-10	
<b>MINI</b>			
MN-001	MINI COOPER S 1.6 L4	03-07	
<b>MAZDA</b>			
MZ-003	MAZDA 626	93-97	
MZ-006	MAZDA PROTEGE 02/PROTEGE 5 2.0L/MP3 01		
MZ-011	MAZDA RX-8 ROTARY 1.3L	04-10	
MZ-012	MAZDA 3 1.6 16V L4	04-10	
MZ-013	MAZDA 3 2.0L/2.3L	04-10	
<b>NISSAN</b>			
N-007/ N-011	NISSAN MARCH (Micra) PRIMERA 1.6GX 16V	92-01	
	NISSAN MARCH	99-10	
NE-001	CHRYSLER NEON	94-00	
NE-003	NEON 2001(FILTER WITH SENSOR HOLE)		
NU-012	NISSAN MARCH L4 16V (ABS)	99-on	
<b>OPEL</b>			
O-001	OPEL ASTRA (1.6)(1.8)		

# AIR INTAKE SYSTEM



M-012



H-032

ITEM NO.	DESCRIPTION	YEARS	MSRP
<b>LEXUS</b>			
LX-001	LEXUS IS300 2002		
<b>MITSUBISHI</b>			
M-001/ M-002	MITSUBISHI LANCER 1.6/VIRAGE 1.8	92-95	
	LANCER 1.6/VIRAGE 1.8	96-00	
M-002B	MITSUBISHI FTO.GR MODEL 6A 12 2.0 V6(with air flow meter only)	94-00	
M-005B	MITSUBISHI PROTON WIRA 12V (dish)		
M-006A	MITSUBISHI PROTON WIRA 8V		
M-006B	MITSUBISHI SAGA 8V (dish)	85-97	
M-008	MITSUBISHI ECLIPSE(Non turbo)	95-99	
<b>PROTON</b>			
M-011	PROTON WIRA 1.3/1.5	96-on	
M-012	PROTON WIRA 1.6		
<b>MINI</b>			
M-013	MITSUBISHI ECLIPSE L4/V6	00	
M-014	MITSUBISHI LANCER 1.6	01-04	
M-014A	MITSUBISHI ALL EFI models with external air flow meter		
M-015	MITSUBISHI LANCER 1.8(TW) 01-06/ LANCER 2.0(USA)	01-06	
M-016	MITSUBISHI LANCER FORTIS 1.8	07-10	
M-017	MITSUBISHI LANCER FORTIS 2.0	07-10	
<b>MINI</b>			
MN-001	MINI COOPER S 1.6 L4	03-07	
<b>MAZDA</b>			
MZ-003	MAZDA 626	93-97	
MZ-006	MAZDA PROTEGE 02/PROTEGE 5 2.0L/MP3 01		
MZ-011	MAZDA RX-8 ROTARY 1.3L	04-10	
MZ-012	MAZDA 3 1.6 16V L4	04-10	
MZ-013	MAZDA 3 2.0L/2.3L	04-10	
<b>NISSAN</b>			
N-007/ N-011	NISSAN MARCH (Micra) PRIMERA 1.6GX 16V	92-01	
	NISSAN MARCH	99-10	
NE-001	CHRYSLER NEON	94-00	
NE-003	NEON 2001(FILTER WITH SENSOR HOLE)		
NU-012	NISSAN MARCH L4 16V (ABS)	99-on	
<b>OPEL</b>			
O-001	OPEL ASTRA (1.6)(1.8)		

ITEM NO.	DESCRIPTION	YEARS	MSRP
O-004	OPEL KADETT E 8V 86-91		
O-005	OPEL KADETT 16V		
<b>PEUGEOT</b>			
PG-007	PEUGEOT 307 2.0 (EW10 J4 L4) 307 2.0	02-05	
	PEUGEOT 307 2.0 CC (HATCH BACK)		
	PEUGEOT 206 2.0 S16/CC (EW10 J4 L4)	99-06	
PG-02	PEUGEOT 205/309 GTI 8V/citroen visa		
PK-001	PERODUA KANCIL		
<b>VOLKSWAGEN</b>			
PL-001	VW POLO(Ibiza) 1.4 16V 01		
PP318A	VW GOLF 1.8 91-97/ SEAT BARCELONA CL4 1.8	93-97	
PP320B	VW GOLF 2.0	95-98	
<b>RENAULT</b>			
RE-001	RENAULT CLIO 2.0 RS	01-04	
<b>SUBARU</b>			
SB-003	SUBARU IMPREZA 1.8	97-01	
<b>SUZUKI</b>			
SZ-001	SUZUKI ESCUDO 1.6	93-98	
SZ-002	SUZUKI Swift 1.5	05-01	
<b>TOYOTA</b>			
T-001	TOYOTA COROLLA	90-92	
T-002/ T-006/ T-009	TOYOTA COROLLA 93-97/CORONA EXSIOR (1.6)/CORONA (2.0)		
T-003	TOYOTA CAMRY (2.2)	92-96	
T-007	TOYOTA CORONA EXSIOR (2.0)		
T-008	TOYOTA CORONA (1.6)		
T-013	TOYOTA ZACE CARBURETOR	88-99	
T-014	TOYOTA KIJANG CARBURETOR	92-00	
T-015	TOYOTA COROLLA	98-01	
T-016	TOYOTA LAND CRUISER V6	98	
T-017	TOYOTA LAND CRUISER V8 4.7L 98-05		
T-018	TOYOTA COROLLA ALTIS 1.8 DOHC 16V VVT-i	01-08	
T-019	TOYOTA TERCEL 1.5	93-02	
T-020	TOYOTA MATRIX XRS 1.8	02-06	
T-021	TOYOTA COROLLA ALTIS 1.6(DOHC 16V)	01-08	
T-022	TOYOTA VIOS 1.5 VVT-i	02-10	
T-023	TOYOTA YARIS 1.5	05-10	
T-024	TOYOTA ALTIS 1.8	08-09	

INTAKE SYSTEM





# AIR INTAKE SYSTEM

INTAKE SYSTEM



## COLD AIR INTAKE SYSTEM

COLD AIR intake system comes with premium Urethane air filter, aluminum piping and all necessary accessories. The system is an up-grade Cold Air Intake by improving all the details. IN addition, the system is extremely light. It definitely is an affordable solid performer.

COLOR

ITEM NO.	VEHICLE MODEL	YEARS	MSRP
ACURA			
AN1CA-05	INTEGRA VEEC 1.8 L4	94-01	
AN1CA-08	INTEGRA LS/GS	94-97	
AN1CA-27	INTEGRA	90-93	
AN1CA-49	INTEGRA TYPE R 1.8	97-01	
AN1CA-45	CLTYPE-S 3.2 V6/TL TYPE-S 3.2 V6	01-03/ 02-03	
AN1CA-47	CL 3.2L /TL 3.2L	02-03	
AN1CA-51	RSX TYPE-S2.0	02-07	
AN1CA-52	RSX BASE M/T	02-07	
AN1CA-66	RSX TYPE S M/T	02-07	
AUDI			
AN1CA-64	A3 1.8T	96-03	

ITEM NO.	VEHICLE MODEL	YEARS	MSRP
CHEVROLET			
AN3CA-36	CAVALIER 2.2L	95-97	
AN1CA-37	CAVALIER 2.2L	98-00	
AN1CA-38	CAVALIER 2.4L	95-02	
CHRYSLER			
AN1CA-25	SEBRING R/T V7 COUPE	01-ON	
AN1CA-28	NEON DOHC MANUAL W/ O ABS	01-ON	
AN1CA-59	NEON SRT-4 16V TURBO	03-ON	
DODGE			
AN1CA-25	SEBRING R/T V6 COUPE	01-ON	
FORD			
AN1CA-29	FOCUS 2.0 ZETEC DOHC	00-04	
HONDA			
AN1CA-01	ACCORD V6	98-01	
AN1CA-07	ACCORD 4CYL	94-97	
AN1CA-10	ACCORD	90-93	
AN1CA-13	ACCORD 4CYL	98-01	
AN1CA-02	CIVIC CRX EX /SI	88-91	
AN1CA-03	CIVIC DX, EX, LX, SI	92-95	
AN1CA-04	CIVIC EX	96-00	
AN1CA-12	CIVIC SI DOHC	99-00	
AN1CA-16	CIVIC DX /LX/CX	96-00	
AN1CA-18	CIVIC ET /MT	01-06	
AN1CA-48	CIVIC DX/LX M/T	01-ON	
AN1CA-14	PRELUDE	92-96	
AN1CA-15	PRELUDE	97-01	
AN1CA-21	S2000	00-01	
AN1CA-62	ACCORD V6 3.0L	03-07	
AN1CA-66	CIVIC TYPE-R (EP3)	01-05	
HYUNDAI			
AN1CA-50	TIBURON 4CY	97-01	
AN1CA-67	TIBURON 2.0	02-ON	
MAZDA			
AN1CA-39	MX-3 V6 SOHC	91-94	
AN1CA-40	MX-3 L4 SOHC	91-94	
AN1CA-42	MX-6 V6	93-98	
AN4CA-56	PROTÉGÉ 5 2.0L /MP3	01-02	
MINI			
AN1CA-58	COOPER S	02-07	
MITSUBISHI			
AN1CA-09	ECLIPSE NONOTURBO 2.0L	95-99	
AN1CA-20	ECLIPSE 3.0 V6	00-03	
AN1CA-25	ECLIPSE V6 3000 GT	00-01	
AN1CA-54	LANCER 1.6	92-95	
AN1CA-60	LANCER	02-04	
NISSAN			
AN1CA-22	SENTRA SE	02-03	
AN1CA-23	MAXIMA 3.0 V6	95-99	
AN1CA-43	240SX S13 NON-TURBO	92-94	
AN1CA-44	240SX S14 NON-TURBO	95-98	
AN1CA-55	SENTRA	01-03	
AN1CA-57	350Z V6	03-08	
AN1CA-65	MAXIMA 3.5L V6	04-08	
SATURN			
AN1CA-35	SC2/SL2	00-02	
SUBARU			
AN1CA-24	IMPR4EZA WRX	01-02	
TOYOTA			
AN1CA-17	CELICA GTS M/T	00-01	
AN1CA-46	MR 2 SPYDER	00-01	
AN1CA-53	COROLLA ALTIS (1.8L, DOHC, 16V VVTI)/TAIWAN	01-07	
AN1CA-61	COROLLA/U.S.A ALL 1.8	01-07	
VW			
AN1CA-64	GOLF IV 1.8T	98-03	

# AIR INTAKE SYSTEM

## ADVANCED INLET ALUMINUM TUBE WITH ANTI-VIBRATION RUBBER

ADVANCED INLET ALUMINUM TUBE WITH ANTI-VIBRATION RUBBER ANTI-VIBRATION DESIGN

Rubber Vibra-reducer allows for cushion against engine movement and torque, relieving stress on the intake.



ITEM NO.	DESCRIPTION	YEARS	MSRP
F-003/	FORD LIATA	93-97	
MZ-01ADV	MAZDA 323 1.5/1.6	93-96	
F-004/	FORD LIATA	97-98	
MZ-04ADV	MAZDA 323 LANTIS	96	
F-006ADV-1	FORD FOCUS SOHC	99-on	
F-006ADV-2	FORD FOCUS DOHC	99-on	
H-002ADV	HONDA CIVIC EG	92-95	
H-003ADV	HONDA CIVIC EK	96-00	
H-010ADV	HONDA CITY		
H-017ADV	HONDA CRV	98	
H-018ADV	HONDA JAZZ/FIT ADV		
H-028ADV	HONDA JAZZ/CITY/FIT 1.5	05-10	
H-018ADV	HONDA JAZZ/FIT ADV		
H-028ADV	HONDA JAZZ/CITY/FIT 1.5	05-10	
M-001/	MITSUBISH LANCER	92-95	
M-002ADV-2	MITSUBISH LANCER	96-97	
M-001/	MITSUBISH LANCER	92-95	
M-002ADV-4	MITSUBISH LANCER	96-97	
M-015ADV	MITSUBISH LANCER 2.0(USA)/1.8(TW) 01	92-95	
MZ-003ADV	MAZDA 626		
N-002ADV	NISSAN ALL NEW SENTER	94-97	
SZ-001ADV	SUZUKI ESCUDO		
T-001ADV	TOYOTA COROLLA	90-92	
T-002ADV	TOYOTA COROLLA	93-97	
T-004ADV	TOYOTA CAMRY V6(3.0)		
T-005ADV	TOYOTA TERCEL		
T-008ADV	TOYOTA RAV4		

### For HONDA CIVIC



### For FORD LIATA



INTAKE SYSTEM





# AIR INTAKE SYSTEM

INTAKE SYSTEM

## FORD MUSTANG COLD AIR INDUCTION SYSTEM

### FORD MUSTANG COLD AIR INDUCTION SYSTEM

The logical extension to the standard OE intake offers you the real cold air, high velocity induction system.

The aluminum Cold Air Intake positions the filter in the right place, ensuring a healthy supply of clean cold air.

**MTU-30**



ITEM NO.	VEHICLE MODEL	YEARS	MSRP
<b>FORD</b>			
MTU30	MUSTANG 4.6L 2V V8 (OLD TYPE)	96-01	
MTU31	MUSTANG 4.6L 2V V8 (NEW TYPE)	96-01	
	MUSTANG 4.6L Cobra Bullit GT	96-on	
	MUSTANG 4.6L Cobra only	03-on	
MTU32	MUSTANG 5.0L V8	94-95	
MTU33	MUSTANG 3.8L V6	96-98	
MTU33-1	MUSTANG 3.8L V6	94-98	
MTU33-2	MUSTANG 3.8L V6	99-03	
MTU34	MUSTANG 5.0L	89-93	

**MTU-31**



**MTU-32**



**MTU-33**



**MTU-34**



## CHEVROLET CORVETTE AIR INTAKE SYSTEM



ITEM NO.	VEHICLE MODEL	YEARS	MSRP
CHU-01	Chevy Corvette 5.7L V8	97-00	
CHU-02	Chevy Corvette 5.7L V8	01-on	

# AIR INTAKE SYSTEM

## MUSCLE POWER TRUCK & SUV KITS

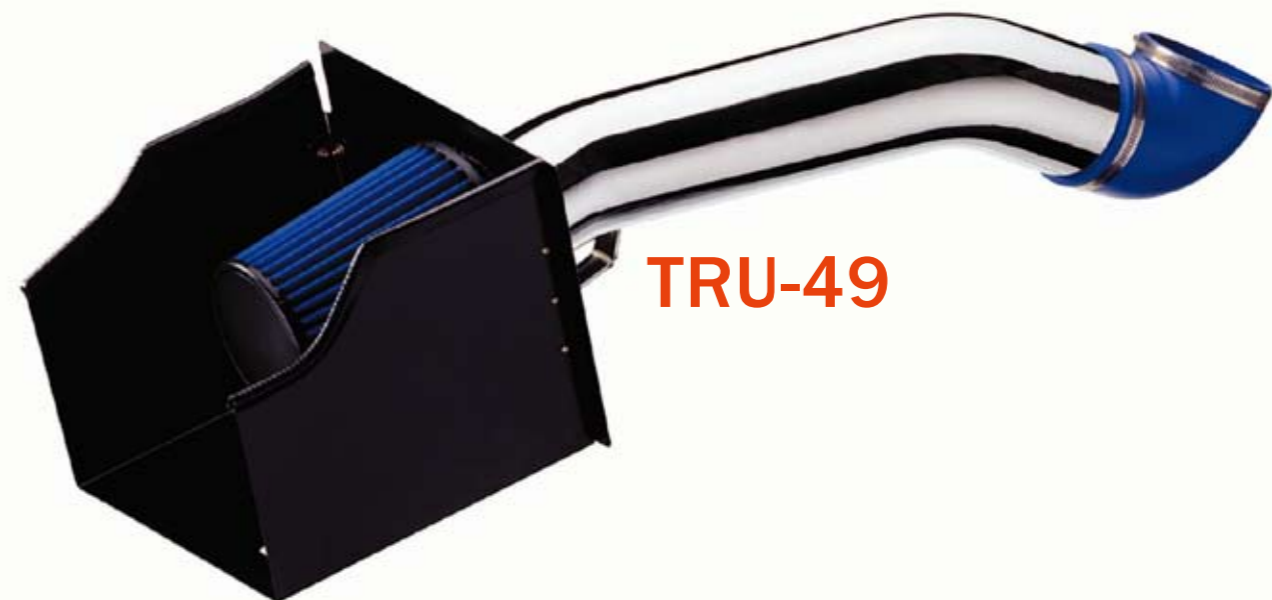

**TRU-49**



**TRU-03**

## TRUCK KITS

SIMOTA TRUCK KITS provide complete applications for almost all popular models.

BRAND NAME	ITEM NO.	DESCRIPTION	YEARS	MSRP	
CHEVROLET/ GMC	TRU-01	BLAZER 4.8/4.8/5.3	00-01		
		JIMMY 4.3/4.8/5.3	00-02		
		SIERRA 4.3/4.8/5.3/6.0	99-02		
		SILVERADO 4.3/4.8/5.3/6.0	99-02		
		SUBURBAN 5.7	98-99		
		SUBURBAN 5.3/6.0	99-02		
		TAHOE 4.8/5.3/6.0	00-01		
		TAHOE 4.3	99-02		
		YUKON 4.3/4.8/5.3	00-02		
		YUKON 4.8/5.3/6.0	00-03		
		TRU-03	SIERRA 4.3/5.0/5.7	88-95	
			SUBURBAN 5.7	92-95	
			YUKON /PICKUP 4.3	87-95	
			YUKON /PICKUP 5.0/5.7	88-95	
			BLAZER S-10 4.3	96-00	
TRU-05	JIMMY S-15 4.3/VORTEC	96-00			
	S10/SONOMA PICKUP 4.3	00-03			

BRAND NAME	ITEM NO.	DESCRIPTION	YEARS	MSRP	
CHEVROLET/ GMC	TRU-06	BLAZER 5.7 VORTEC	96-99		
		DENALI 5.0/5.7	99-00		
		C/K 454 VORTEC	96-00		
		ESCALADE 350 VORTEC	99-00		
		PICKUP 5.0/5.7	96-99		
		SUERRA 4.3/5.0/5.7/7.4	96-00		
		SUBURBAN 5.7/7.4	96-99		
		TAHOE 5.7 VORTEC	96-99		
		YUKON 5.0/5.7/7.4	96-99		
		DODGE	TRU-04	DAKATA 2.5 /3.9/5.2/5.9	97-02
DURANGO 3.9/5.2/5.9	97-02				
TRU-07	RAM 5.3/5.9/3.9(V6)		94-00		
	RAM 3.9/5.2/5.9		01		
TRU-13	DAKOTA 4.7		00-01		
	DURANGO 4.7		00-01		
TRU-16	RAM 4.7L 5.3/5.9/3.9(V6)		94-00		
TRU-47	RAM 1500/2500/3500 5.9L New Body		02-03		
FORD	TRU-02		EXPEDITION 4.6 /5.4	97-03	
			F-150 4.6/5.4	97-03	
TRU-20	POWR STROKE DIESEL 7.3	99-04			
JEEP	TRU-10	TJ 2.5/4.0	97-01		
	TRU-41	WRANGLER 4.0	97-02		
	TRU-43	LIBERTY 3.7	02		
TOYOTA	TRU-44	TACOMA 4CYL	97-99		
	TRU-45	4 RUNNER 3.4L V6	99-02		
	TRU-46	TUNDRA 4.7 V8 F/1	00-02		
HUMMER	TRU-49	H2 6.0L V8	03-04		

INTAKE SYSTEM





INTAKE SYSTEM



*Urethane Air Filter for Truck*



JAU-G02201-II    JAU-K05201-II    JAU-H09210-15    JAU-H10211-15    JAU-H02212-15

## TRUCK KITS

SIMOTA is proud to release the new premium Urethane constructed air filters and High Density Polyethylene ( HDPE) intake pipes, engineered to maximize your sport truck's performance.

ITEM NO.	VEHICLE MODEL	YEARS	MSRP
KTR-01A	CADILLAC		
	CADILLAC ESCALADE 5.3/6.0L V8 F/I	02-03	
	CADILLAC ESCALADE EXT 6.0L V8 F/I	02-03	
	CHEVROLET		
	CHEVROLET SILVERADO 2500 5.3/6.0L V8 F/I	99-03	
	CHEVROLET SILVERADO 3500 6.0L V8 F/I	01-03	
	CHEVROLET SIERRA /SILVERADO 1500HD 6.0L V8 F/I	01-03	
	CHEVROLET TAHOE 4.8/5.3L V8 F/I	00-03	
	CHEVROLET SUBURBAN 6.0/5.3L V8 F/I	00-03	
	GMC		
	GMC SIERRA 2500 5.3/6.0L V8 F/I	99-03	
	GMC SIERRA 3500 6.0L V8 F/I	99-03	
	GMC YUKON 4.8/5.3L V8 F/I	00-03	
	GMC YUKON DENALI 4.8/5.3L V8 F/I	01-03	
	GMC YUKON XL 5.3/6.0L V8 F/I	00-03	
GMC YUKON XL DENALI 6.0L V8 F/I	01-03		
KTR-01B	CHEVROLET		
	CHEVROLET SILVERADO 4.8/5.3L V8 F/I	99-03	
	GMC		
KTR-02	FORD		
	FORD EXPEDITION 4.6/5.4L V8 F/I	97-02	
	FORD F150 4.6/5.4L V8 F/I	97-02	
	FORD F250 5.4L V8 F/I	97-02	
	LINCOLN		
LINCOLN NAVIGATOR 5.4L V8 F/I	98-99		

ITEM NO.	VEHICLE MODEL	YEARS	MSRP
KTR-03	CHEVROLET		
	CHEVROLET SILVERADO 4.3/5.0/5.7L V8	88-95	
	GMC		
	GMC SIERRA 4.3/5.0/5.7L V8	88-95	
	GMC SUBURBAN 5.7L V8	92-95	
	GMC YUKON 5.0/5.7L V8	92-95	
	DOGDE		
	DAKOTA 3.9/5.2/5.9L V6	97-03	
	DURANGO 3.9/5.2/5.9L V8	97-03	
	KTR-05	CHEVROLET	
CHEVROLET BLAZER S-10/S10 PICKUP 4.3L V6 F/I		96-03	
CHEVROLET C/K 4.3L V6		96-98	
CHEVROLET SILVERADO 5.7L V8		96-00	
CALDILLAC			
CALDILLAC ESCALADE 5.7L V8		99-00	
GMC			
GMC JIMMY S-15 4.3L V6 F/I		96-01	
GMC SONOMA 4.3L V6 F/I		96-03	
GMC SIERRA 4.3/5.0/5.7L V8		96-00	
KTR-07	DODGE		
	DODGE RAM 3.9/5.2/5.9L	94-01	
	CHEVROLET		
	CHEVROLET SILVERADO 7.4L V8	96-00	
	GMC YUKON 5.0/5.7L V8	96-99	
	GMC YUKON DENALI 5.0/5.7L V8	99-00	
	GMC SIERRA 4.3/5.0/5.7L V8	96-00	
	GMC SONOMA 4.3L V6 F/I	96-03	
	GMC YUKON 4.8/5.3L V8 F/I	00-03	
	GMC YUKON XL 5.3/6.0L V8 F/I	00-03	

ITEM NO.	VEHICLE MODEL	YEARS	MSRP
KTR-07	GMC		
	GMC SIERRA 7.4L V8	96-00	
	GMC SUBURBAN 7.4L V8	96-99	
	GMC YUKON 7.4L V8	96-99	
	JEEP		
	JEEP WRANGLER(TJ) 2.5L L6	97-04	
KTR-13	DODGE		
	DODGE DAKOTA / DURANGO 4.7L V8 F/I	00-03	
	DODGE RAM 1500/2500 4.7L V8	02-03	
	DODGE RAM 1500/2500 4.7L V8	02-03	
	FORD		
FORD SUPER DUTY 7.3L DIESEL	99-01		
KTR-22	FORD		
	FORD EXCURSION 6.8L V10 F/I	00-03	
	FORD F250/350 SUPER DUTY 5.4L V8 F/I	99-03	
KTR-26	FORD		
	FORD EXCURSION 5.4L V8 F/I	00-03	
	FORD F250/350 SUPER DUTY 5.4L V8 F/I	99-03	
KTR-36	CHEVROLET		
	CHEVROLET S10 PICKUP 2.2L L4 F/I	98-03	
	GMC		
GMC SONOMA 2.2L L4 F/I	98-03		
KTR-39	CHEVROLET		
	CHEVROLET ASTRO VAN 4.3L V6	96-01	
	GMC		
GMC SAFARI 4.3L	96-01		

ITEM NO.	VEHICLE MODEL	YEARS	MSRP
KTR-41	JEEP		
	JEEP WRANGLER 4.0L L6 F/I	97-03	
KTR-42	JEEP		
	JEEP GRAND CHEROKEE 4.7L V8 F/I	99-03	
KTR-44	JEEP		
	JEEP LIBERTY 3.7L V6	02-03	
KTR-44	TOYOTA		
	TOYOTA 4RUNNER 2.7L L4 F/I	00-01	
	TOYOTA TACOMA 2.4/2.7L L4 F/I	00-03	
KTR-45	TOYOTA		
	TOYOTA TACOMA 2.4/2.7L L4	95-99	
	TOYOTA 4RUNNER 3.4L V6 F/I	99-02	
KTR-46	TOYOTA		
	TOYOTA TACOMA 3.4L V6 F/I	99-03	
	TOYOTA TUNDRA 4.7L V8		
KTR-63	CHEVROLET		
	CHEVROLET SILVERADO 1500 4.3L V6 F/I	99-03	
	GMC		
GMC SIERRA 1500 4.3L V6 F/I	99-03		
KTR-67	DODGE		
	DODGE RAM 1500 5.2/5.9L V8 F/I	94-01	
	DODGE AM2500 5.9L V8 F/I	94-02	

INTAKE SYSTEM





# AIR INTAKE SYSTEM

## HEXAGON MUSHROOM INTAKE SYSTEM

Available for universal applications, the unique design of SIMOTA HEXAGON MUSHROOM SIMOTA SPIRAL MUSHROOM combats the typical stock design that generates turbulence and reduces airflow capacity when the propensity of airflow moves toward surface areas. SIMOTA HEXAGON MUSHROOM /SIMOTA SPIRAL MUSHROOM is made up of a fine foam which offer an optimal balance of air filtration and increased airflow for maximum performance and protection. SIMOTA's unique-funnel design, with its vacuum-inducing inner horn, draws air from the filter's outer edge and directs air away from inlet throat surface areas.

SIMOTA HEXAGON MUSHROOM is made up of a fine foam which offers optimal balance of air filtration and increased airflow for maximum performance and protection.

SIMOTA's unique-funnel design, with its vacuum-inducing inner horn, draws air from the filter's outer edge and directs air away from inlet throat surface areas.

The outer frame is a hexagonal honeycomb design, which helps improving air intake's. The performance of air intaker honeycomb-like and the colorful outlooking can dress up engine compartment.

INTAKE SYSTEM

HS-101 TOYOTA YARIS 1.5 05-0N



HS-103 TOYOTA ALTIS 1.6 1.8 01-0N.JPG



HS-102 TOYOTA WISH 1.8 2.0 03-0N



HS-201 HONDA FIT-JAZZ CITY 1.3 1.5 05-0N



ITEM NO.	DESCRIPTION	YEARS	MSRP
HS-101	TOYOTA YARIS 1.5	05-10	
HS-102	TOYOTA WISH /2.0	05-10	
HS-103	TOYOTA ALTIS 1.6/1.8	01-07	
HS-104	TOYOTA VIOS 1.5	03-07	
HS-105	TOYOTA TERCEL 1.5	93-03	
HS-106	TOYOTA CORLLA ALTIS II 1.8	07-10	
HS-201	HONDA FIT/JAZZ/CITY 1.5	05-07	
HS-202	HONDA CIVIC VTEC 1.6 V / VI	92-00	
HS-203	HONDA CIVIC 1.8	06-10	
HS-204	HONDA ACCORD	90-93	
HS-205	HONDA ACCORD 4CY	94-97	
HS-206	HONDA ACCORD 4CY	98-02	
HS-207	HONDA CITY 1.5	96-00	
HS-208	HONDA CIVIC 2.0	06-10	
HS-209	HONDA JAZZ/FIT 1.3&1.5	08-10	
HS-301	NISSAN TEANA CEFIRO 2.0/2.3/3.5	05-10	
HS-401	SUZUKI SWIFT	05-10	
HS-402	SUZUKI JP 2.7 GRAND VITARA	07-10	
HS-501	MITSUBISHI LANCER FORTIS 2.0	07-10	
HS-502	MITSUBISHI LANCER FORTIS 1.5	07-10	

# 3in1 Performance Oil Filter



Honeycomb spiral column design helps oil form Super Oil Vortex therefore it increases oil pressure of the engine.



Stainless Steel Mesh with pleats provides superior oil filtration thus increase work efficiency of the engine oil flow, oil flow rate, and decreases. It not only increases the horse power and torque but also saves cost and fuel.

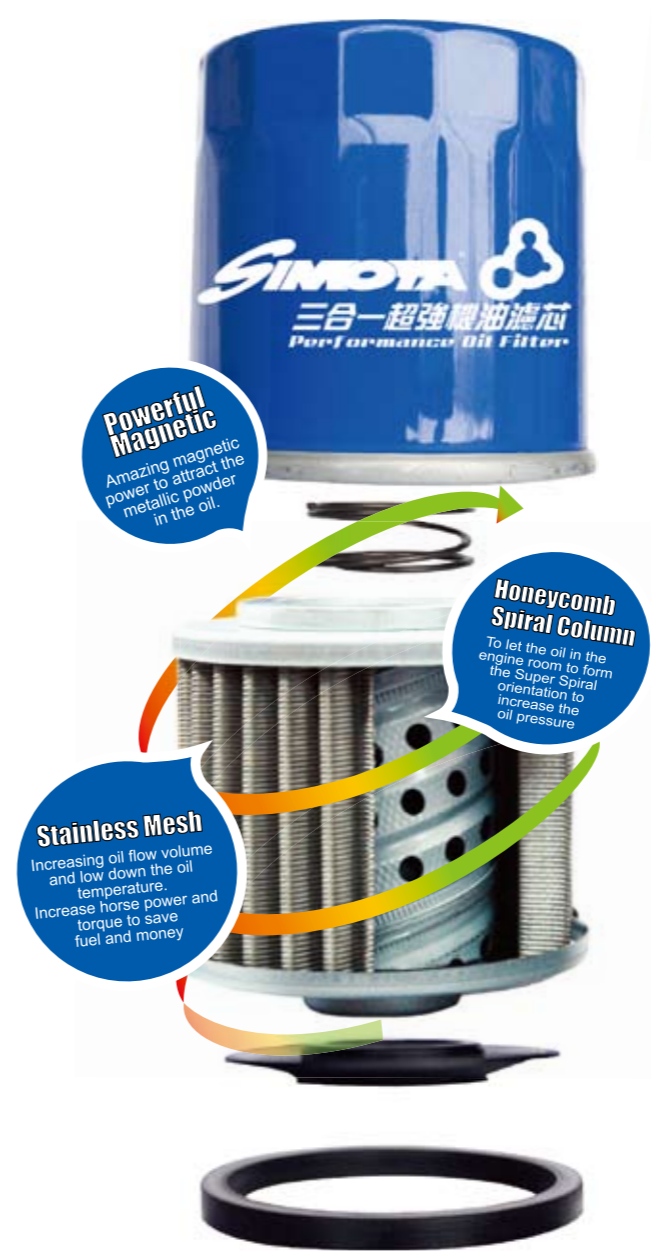

### Installation Notices:

1. Apply oil to sealing gasket face before instaling.
2. When gasket makes contact with sealing face, tighten with appropriate tool.
3. To check for oil leaking after installation.

JP M20	OUTER	THREAD GAUGE	HEIGHT	WRENCH	MSRP
	68	M20*P1.5	85	68Ø	

HONDA, NISSAN, MITSUBISHI, MAZDA, SUBARU, KIA, RENAULT(CLIO), HYUNDAI

JP 3/4	OUTER	THREAD GAUGE	HEIGHT	WRENCH	MSRP
	68	3/4*-16UNF	85	68Ø	

TOYOTA, NISSAN (MARCH), DAIHATSU, FORMOSA, SUZUKI

EU M20	OUTER	THREAD GAUGE	HEIGHT	WRENCH	MSRP
	68	M20*P1.5	85	68Ø	

ALFA ROMEO, CHRYSLER, CITROEN, FIAT PEUGEOT, RENAULT(R19), VOLVO(340, 440, 460)

EU 3/4	OUTER	THREAD GAUGE	HEIGHT	WRENCH	MSRP
	76	3/4*-16UNF	87	76Ø	

TOYOTA(CAMRY 3.0, HIACE 2.5/3.0), LANCIA, CHRYSLER(NEON), HYUNDAI(TUCSON 2.0/2.7), LEXUS, FORD, RENAULT(R9), ROVER, AUDI, MAZDA(TRIBUTE 2.0, MAZDA 3, MAZDA 6) PEUGEOT(305 1.5), SAAB, SATURN, BMW VOLKSWAGEN, VOLVO, MERCEDES-BENZ





ACCESSORIES

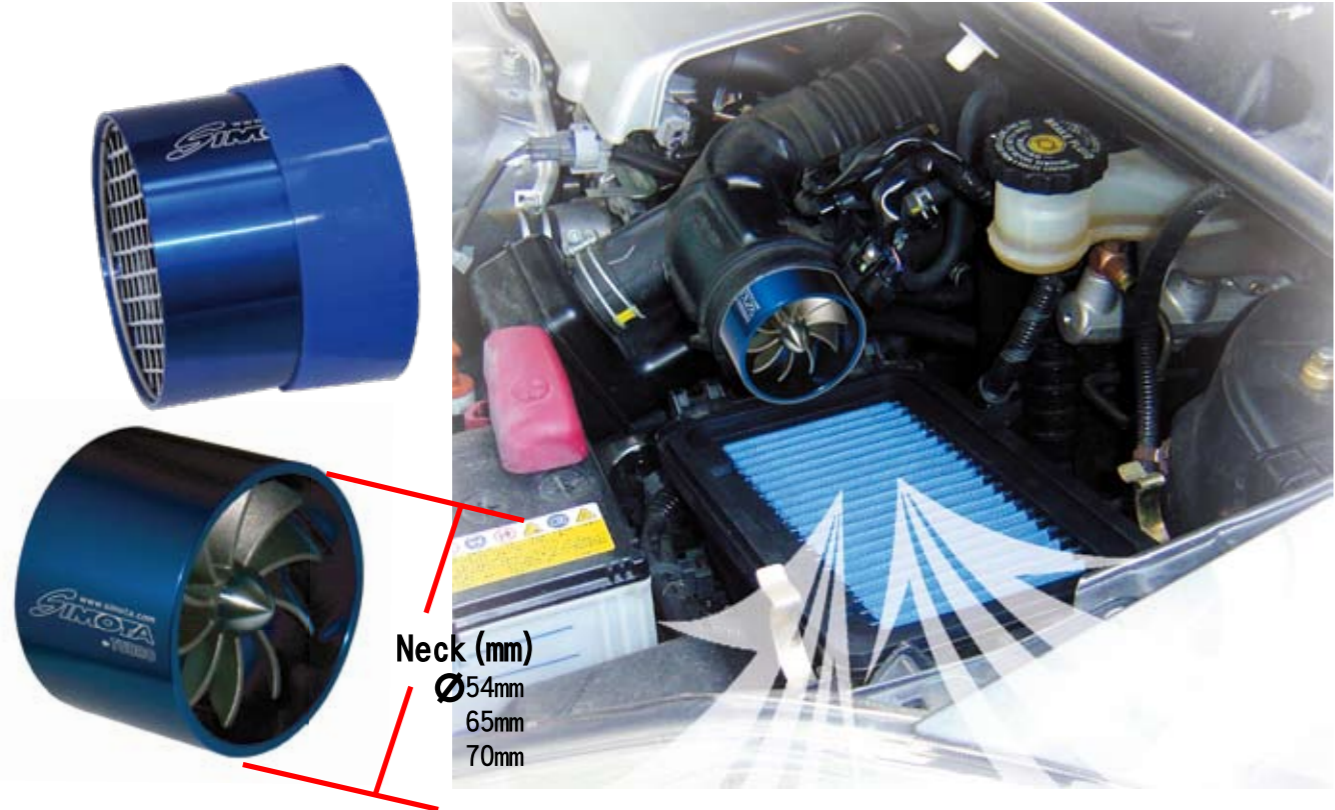

ITEM NO.	NECK(mm)
CT-526	55~64mm
CT-626	65~70mm
CT-726	71~78mm

**FITS ALL ENGINES**

CAR BRAND	NECK(mm)	
TOYOTA	56~65mm	(800C.C-2000C.C)
MAZAD	71mm	(over 2000C.C-)
FORD	56~71mm	(800C.C-over 2000C.C-)
HONDA	71mm	(over 2000C.C-)
MISUBISHI	71mm	(over 2000C.C-)
NISSAN	65mm	(1300C.C-2000C.C)

1. Improved fuel economy
2. Instant increase in engine power
3. Reduction in carbon accumulation to your engine
4. Minimized air pollution
5. Enhanced throttle response and acceleration
6. Easy to install, DIY

**Instruction**

1. Location of installation: Install the product between the air filter and the throttle body, into the middle of air inlet pipe. (Propeller side face to the air filter)
2. Optimal location: Install the product 10 cm to 30 cm in front of the inlet throttle body.
3. When the inlet pipe is curved, you can install Super Spiral into the middle of dual bend pipe.
4. If the car is equipped with air flow sensors(AIF), install a Super Spiral before or after AIF with the same size. When there is minor difference in size, you can wrap a few rounds of tape on outer rim.
5. The products can be installed to gasoline & diesel cars, as long as there is the inlet pipe on the air inlet of the throttle.

SIMOTA'S high speed SUPER SPIRAL creates a vortex air flow to improve air & fuel mixture enhancing your engine's performance. It reduces the carbon accumulation in the engine and substantially increases the horsepower to your engine.

SUPER SPIRAL TURBO VENTILATOR blades are made of advanced precision bearing technology (running up to 30,000 RPM). Aluminum Alloy Gravity Diecasting design is not only anti-rust, but also has the ability to match your high-revving engine.

The blades have special angles to promote extra air flow to the inlet manifold and assist in providing better engine combustion. Experience strong torque during low to medium RPM ranges but also extreme horsepower at higher engine revolutions.

The upgraded fuel combustion can reduce carbon accumulation to your engine. Furthermore, it is environment friendly and greatly increases performance efficiency.



Item no.:	Thread Gauge	Height	Wrench	Application	MSRP
CZJP-65MI20-NR	M20*P1.5	65mm	68Ø	Honda, Nissan, Mitsubishi, Subaru, Kia, Mazda, Renault(Clio), Hyundai	
CZJP-65PT43-NR	3/4"-16UNF	65mm	68Ø	Toyota, Nissan(March), Daihatsu, Formosa, Suzuki	
CZJP-85MI20-NR	M20*P1.5	85mm	68Ø	Handa, Nissan, Mitsubishi, Subaru, Kia, Mazda, Renault(Clio), Hyundai	
CZJP-85PT43-NR	3/4"-16UNF	85mm	68Ø	Toyota, Nissan(March), Daihatsu, Formosa, Suzuki	
CZEU-85MI20-NR	M20*P1.5	85mm	76Ø	Alfa Romeo, Chrysler, Citroen, Fiat, Peugeot, Renault(R19), Volvo(340,440,460)	
CZEU-85PT43-NR	3/4"-16UNF	85mm	76Ø	Toyota(Camry 3.0), Hiace 2.5/3.0, Lancia, Chrysler(Neon), Hyundai(Tucson 2.0/2.7), Lexus, Ford, Renault(R9), Rover, Audi, Mazda(Tribute 2.0, Mazda 3, Mazda 6)Peugeot(305 1.5), Saab, Saturn, BMW, Volkswagen, Volvo, Mercedes-Benz	

**MAGNETIC SCREW**

collects metal debris in the motor oil, helping to maintain oil quality and reduce mechanical wear.

- MS-007 (Titanium)  
Mitsubishi, Ford, Honda, GM mode
- MS-008 (Silver)  
Nissan, Toyota, GM mode
- MS-009(Blue)  
SUBARU mode 97-on



MS-007 MS-008 MS-009

ACCESSORIES





HIGH QUALITY SILICONE WITH 4 LAYERS OF POLYESTER FABRIC

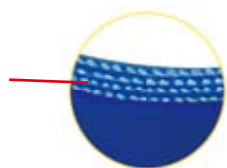

### Silicone Straight 1 Meter

ITEM NO.	DESCRIPTION(mm)	LENGTH	MSRP
RR-51Z	51X51	1m	
RR-60Z	60X60	1m	
RR-63Z	63X63	1m	
RR-70Z	70X70	1m	
RR-76Z	76X76	1m	
RR-80Z	80X80	1m	
RR-89Z	89X89	1m	
RR-95Z	95X95	1m	



### Silicone Straight

ITEM NO.	DESCRIPTION(mm)	LENGTH	MSRP
RR-51H	51X51	70mm	
RR-54H	54X84	155mm	
RR-60H	60X60	70mm	
RR-63H	63X63	70mm	
RR-70E	70X70	50mm	
RR-70H	70X70	70mm	
RR-76D	76X76	45mm	
RR-76H	76X76	70mm	
RR-80E	80X80	50mm	
RR-80H	80X80	70mm	
RR-89F	89X89	55mm	
RR-89H	89X89	70mm	
RR-89I	89X89	70mm	
RR-95E	95X95	50mm	



### Silicone Reducer

ITEM NO.	DESCRIPTION(mm)	LENGTH	MSRP
RP-5063A	50X50	76mm	
RP-5563A	55X63	76mm	
RP-6070A	60X70	76mm	
RP-6076A	60X76	76mm	
RP-6276A	62X76	76mm	
RP-6570A	65X70	76mm	
RP-6776A	67X76	76mm	
RP-7076A	70X76	76mm	
RP-7076C	70X76	40mm	
RP-7080A	70X80	76mm	
RP-7089A	70X89	76mm	
RP-7089G	70X89	60mm	
RP-7680A	76X80	76mm	
RP-7689A	76X89	76mm	
RP-7689F	76X89	55mm	

### SIMOTA SILICONE COUPLER

is made of high quality silicone with 4 plies of polyester fabric. SIMOTA SILICONE COUPLER is not only more durable, but also gifted with the ability of anti-heat, anti-oil, anti-expansion, and anti-pressure. SIMOTA SILICONE COUPLER makes you driving safely even though driving long for distance on high speed .



### Silicone Hump

ITEM NO.	DESCRIPTION(mm)	LENGTH	MSRP
RT-51A	51X51	76mm	
RT-63A	63X63	76mm	
RT-70A	70X70	76mm	
RT-76A	76X76	76mm	



### Silicone Elbow

ITEM NO.	DESCRIPTION(mm)	LENGTH	MSRP
RQ-70G	70X70	48°	



### Silicone Elbow

ITEM NO.	DESCRIPTION(mm)	LENGTH	MSRP
RV-70G	70X70	58°	



### Silicone 50° Rainbow

ITEM NO.	DESCRIPTION(mm)	LENGTH	NOTE	MSRP
RQ-51B	51X51	125mm	50°	
RQ-63B	63X63	125mm	50°	
RQ-70B	70X70	125mm	50°	
RQ-76B	76X76	125mm	50°	



### Silicone 90° Rainbow

ITEM NO.	DESCRIPTION(mm)	LENGTH	NOTE	MSRP
RO-51B	51X51	125mm	90°	
RO-63B	63X63	126mm	90°	
RO-70B	70X70	127mm	90°	
RO-76B	76X76	128mm	90°	
RO-6270B	70X70	129mm	90°	



### Silicone 135° Rainbow

ITEM NO.	DESCRIPTION(mm)	LENGTH	NOTE	MSRP
RS-70B	70X70	125mm	135°	
RS-76B	76X76	125mm	135°	

# REDUCER



### ANTI-VIBRATION RUBBER

ITEM NO.	INNER DIAMETER/DESCRIPTION	COLOR	MSRP
AN-1	76x76(mm) 7 layers	BLACK	
AN-2	76x76(mm) 4 layers	BLACK	
AN-3	70x76(mm) 4 layers	BLACK	
AN-4	63.5x76(mm) 3 layers	BLACK	
AN-5	63.5x70(mm) 3 layers	BLACK	
AN-6	70x70(mm) 3 layers	BLACK	
AN-7	63.5x63.5(mm) 3 layers	BLACK	
AN-8	114x114(mm) 1 layers	BLACK	
AN-9	80x80(mm) 1 layers	BLACK	
AN-10	76x76(mm) 1 layers	BLACK	
AN-11	70x70(mm) 1 layers	BLACK	
AN-12	63.5x70(mm) 1 layers	BLACK	
AN-13	63.5x63.5(mm) 1 layers	BLACK	
AN-14	63.5x70(mm) 1 layers	BLACK	
AN-15	89x89(mm) 1 layers	BLACK	
AN-16	45x50(mm) 3 layers	BLACK	
AN-17	70x76(mm) 1 layers	BLACK	



### 45° / 90° COUPLER

ITEM NO.	INNER DIAMETER/DESCRIPTION	COLOR	MSRP
NR-1	62x65(mm) / (90° Coupler)	BK	
NR-2	62x76(mm) / (90° Coupler) / aperture	BK	
NR-3	63.5x80(mm) / (90° Coupler)	BK	
NR-4	67x76(mm) / (90° Coupler)	BK	
NR-5	62x76(mm) / (90° Coupler) / non-aperture	BK	
NR-6	70x105(mm) / (90° Coupler)	BK	
NR-7	60x70(mm) / (90° Coupler) / aperture	BK	
NR-8	60x70(mm) / (90° Coupler) / non-aperture	BK	
NC-1	70x70(mm) / (90° Coupler)	BK	
NC-2	76x76(mm) / (90° Coupler)	BK	
NC-3	70x70(mm) / (45° Coupler)	BK	
NC-4	101x101(mm) / (90° Coupler)	BK	
NC-5	70x70(mm) / (50° Coupler)	BK	
NC-6	38x38(mm) / (45° Coupler)	BK	
NC-7	42x42(mm) / (45° Coupler)	BK	
NC-8	48x48(mm) / (45° Coupler)	BK	
NC-9	70x70(mm) / (50° Coupler) short	BK	

NOTE:R-Red / B-Blue / BK-Black



### REDUCER

ITEM NO.	INNER DIAMETER/DESCRIPTION	COLOR	MSRP
RDC-1	54x76(mm)	BK / B	
RDC-2	62x76(mm)	BK / B	
RDC-3	67x76(mm)	BK / B	
RDC-4	76x83(mm)	BK / B	
RDC-5	76x89(mm)	BK / B	
RDC-6	59x76(mm)	BK / B	
RDC-7	70x80(mm)	BK / B	
RDC-8	76x80(mm)	BK / B	
RDC-9	60x70(mm)	BK / B	
RDC-10	80x89(mm)	BK / B	
RDC-11	89x95(mm)	BK	
RDC-12	50x62(mm)	BK / B	
RDC-13	70x76(mm)	BK / B	
RDC-14	58x76(mm)	B	
RDC-15	101x114(mm)	BK / B	
RDC-16	95x101(mm)	B	
RDC-17	64x89(mm)	B	
RDC-18	89x101(mm)	BK	
RDC-19	65x70(mm)	BK	
RDC-20	64x86(mm)	BK/B	

NOTE:B-Blue / BK-Black



### COUPLER

ITEM NO.	INNER DIAMETER/DESCRIPTION	COLOR	MSRP
CP-1	62x62(mm)	BK/ B/ R	
CP-2	70x70(mm)	BK/ B/ R	
CP-3	76x76(mm)	BK/ B/ R	
CP-4	89x89(mm)	BK/ B	
CP-5	65x65x40(mml)	BK	
CP-6	114x114x55(mml)	BK	
CP-7	101x101x35(mml)	BK	
CP-8	101x101x50(mml)	BK	

NOTE:R-Red / B-Blue / BK-Black



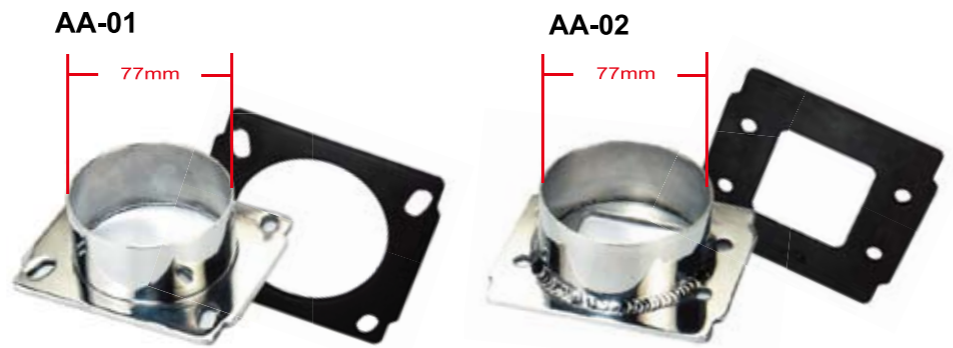
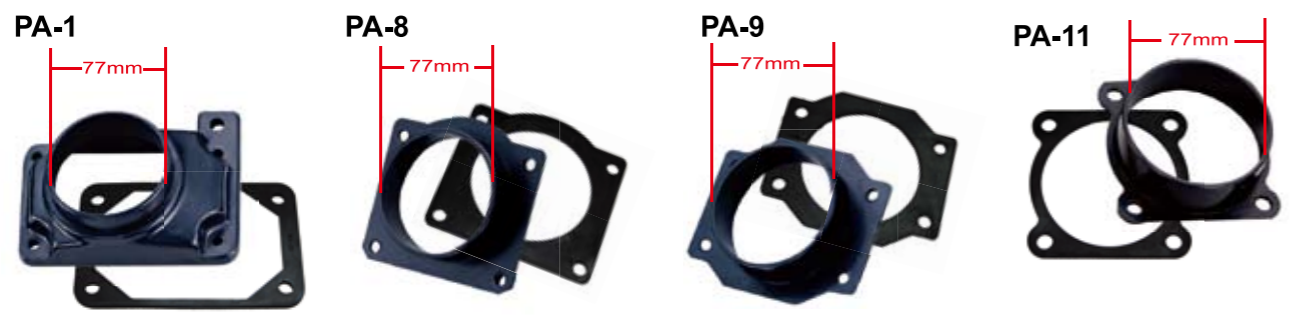

Installation Chart  
Air Filter Not Included

ITEM NO.	DESCRIPTION	MSRP
PA-1	Mitsubishi Pajero/ EVO 7,8,9 Mitsubishi Galant 98-01 Mitsubishi Lancer 92-00 Mitsubishi Eclipse Turbo Mitsubishi Virage	
PA-7	Nissan Sentra 90-93	
PA-9	Nissan All NEW Sentra 94-97 Nissan HV Nissan Cefiro 98 Nissan Primera 97 Nissan Maxima	
PA-11	Nissan Sentra 180	
PA-15	Nissan SE 2002	
PA-8	Nissan Altima 95 Nissan 200SX Nissan Primera 92-96	
PA-10	BMW E30/E36 318i Toyota Camry 88-91 VW Golf Mazda 323 88-92	
PA-5	Subaru Legacy 90-94 Subaru Impreza GT 97	
PA-6	Subaru Impreza GT 99-01	
PA-14	AUDI A3 94-97/VW Golf IV,1.6 8V	

ITEM NO.	DESCRIPTION	MSRP
PK-23	Mitsubishi Pajero/ EVO 7,8,9 Mitsubishi Galant 98-01 Mitsubishi Lancer 92-00 Mitsubishi Eclipse Turbo Mitsubishi Virage	
PK-24	Nissan All NEW Sentra 94-97 Nissan HV Nissan Cefiro 98 Nissan Primera 97 Nissan Maxima Nissan Altima 95 Nissan 200SX Nissan Primera 92-96 Subaru Legacy 90-94 Subaru Impreza GT 97 Subaru Impreza GT 99-01	

AA-01 APPLICATIONS	MSRP
FORD CONTOUR	95-98
Escort Ix	93-
Probe Se	93-
INFINITI G20	91-96
MERCURY Tracer	93-
NISSAN Sentra	91-94
Stanza	90-92
240SX	88-94
Altima	93-96
NX2000	91-
Pulsar NX / SE	87-90
SUZUKI Swift	89-94
VW Golf III	93-
Jetta III	93-
Passat	93-

AA-02 APPLICATIONS	MSRP
BMW 325	87-91
M3	97-91
FORD Probe	89-92
MAZDA 323	90-95
626	85-92
929	85-91
Miata	90-93
MPV V6	89-95
MX-3 4cyl	92-93
Protégé	90-95
NISSAN 200SX	95-
240SX	95-
Sentra	95-99
PORSCHE 944S	83-91
4 Runner	90-95
TOYOTA Camry	87-91
Camry V6	92-93
Celica GT	86-89
Celica GT	94-96
MR2 Turbo	91-95
MR2 Non Turbo	91-95
Cressida	89-92
Previa	91-96
Supra Non Turbo	86-92
LAND CRUISER T-100	93-94
Truck	89-95
Truck	88-96
LEXUS ES250	90-91
ES300	92-93
GS300	93-96
LS400	90-94
VW Golf III	87-92
Jetta III	87-92
Passat	87-92

## SENSOR ADAPTOR



Item No	Description	MSRP
AG-002PP	LEXUS IS-250 06-09	
AG-003PP	LEZUS IS-300 3.0 01-09	
AG-004PP	FORD TIERRA 1.6 00-09 MAZDA ISUMU 1.6 00-09	
AG-005PP	HONDA CIVIC 1.8 08-09 NISSAN TIIDA 1.8 05-09	
AG-006PP	NISSAN SENTRA 1.6/1.8/2.0 04-09 FORD FOCUS TDCI 2.0 07-09	
AG-011PP	VW BEETLE 1.6 01-09 VW GOLF IV 1.6 97-03 VW BORA 1.6 8V 97-03	
AG-013PP	FORD FOCUS ST170 2.0 02-09 FORD ESCAPE 2.0 01-09 FORD FOCUS RS 2.0T 02-04 MITS OUTLENDER 2.4 03-09	
AG-015PP	SUZUKI JP 2.7 07-09 NISSAN TEANA(CERFIO) 2.0/2.3/3.5 04-09 INFINITI FX35 3.5 03-09	
AG-016PP	HONDA CIVIC 2.0 08-09 TOYOTA CAMRY 2.0 06-09 TOYOTA RAV4 2.4 08-09	
AG-017PP	TOYOTA VIOS 1.5 03-09 TOYOTA YARIS 1.5 05-09 SUZUKI SWIFT 1.5 05-09	
AG-022PP	FORD ESCAPE 3.0 04-09 MAZDA TRIBUTE 3.0 04-09	
AG-024PP	SUZUKI SX4 1.5 07-09	
AG-025PP	NISSAN TIIDA 1.6 05-09	
AG-026PP	TOYOTA WISH 04-09	
AG-027PP	HONDA FIT 1.5 08-09	
AG-028PP	NISSAN SENTRA 1.6/1.8/2.0 99-04 VW GOLF IV 2.0 97-03 VW BORA 2.0 97-03 VW BETTLE 2.0 99-09	

Item No	Description	MSRP
AG-029PP	AUDI A4 2.0 5V 01-09 AUDI S3 1.8T 99-09	
AG-030PP	BMW E60 520I/525I/523I 03-09	
AG-031PP	AUDI TT 1.8T 215HP(QUATTRO) 00-09 VW GOLF IV R32 3.2 02-04	
AG-032PP	SUBARU IMPREZA 1.5 08-09	
AG-033PP	NISSAN LANCER FORTIS 1.8 07-09	
AG-034PP	MAZDA 3 1.6/2.0 04-09 MAZDA 6 2.0/2.3 03-07 MAZDA 6 2.5 08-09 MAZDA 5 2.0 06-09 TOYOTA ALITS 1.6/1.8 01-07	
AG-035PP	HONDA CRV 2.4 08-09	
AG-036PP	HONDA ACCORD 2.4 08-09	
AG-037PP	MAZDA RX-8 1.3 03-09	
AG-038PP	BMW E87 130I(UF30) 05-09 BMW E90 330/325 05-09 BMW E90 320I 05-09	
AG-039PP	NISSAN LANCER FORTIS 2.0 07-09	
AG-040PP	SUZUKI SX4 1.6 08-09(CHINA)	

## SIMOTA IMPREZA COLLECTION

TWIN CHARGER TECHNOLOGY  
VARIED LENGTH AND DIAMETER OF PIPING  
WITH VENTERI EFFECT.

ITEM NO.	DESCRIPTION	YEAR	MSRP
SB-04	SUBARU IMPREZA GT2.0(GC8)(TURBO2.0)MK1	93-97	
SB-05	SUBARU IMPREZA GT2.0(GC8)(TURBO2.0)MK2	93-97	
SB-06	SUBARU IMPREZA WRX/WRX STI/FORESTER2.0	01-on	
SB-07	SUBARU IMPREZA WRX/WRX STI/FORESTER2.0	01-on	



SB-04



SB-05



## REINFORCED MUFFLER RUBBER HANGERKIT



**HR-003** 8mm  
**HR-002** Ø10mm



## PU HOSE



### PU HOSE

ITEM NO.	INNER DIAMETER (mm)
HS-1	5 / 10
HS-2	10 / 16
HS-3	12 / 18
HS-4	14 / 21
HS-5	16 / 22
HS-6	4 / 10
HS-7	7.9 / 15



## SILICONE HOSE KIT



### SILICONE HOSE

ITEM NO.	INNER DIAMETER (mm)
SHS-1	5 / 10
SHS-2	10 / 16
SHS-3	12 / 18
SHS-4	15 / 21
SHS-5	20 / 26
SHS-6	28 / 34



• Available in: Red / Blue / Yellow

## POWER BRAKE AUXILIARY



PB-01-3

POWER BRAKE AUXILIARY  
Pressure Test by LS-1840 Air Leakage  
Test Chamber of ARTC

## OIL CATCH TANK

OIC CATCH TANK

The Simota oil catch tank adds to the PVC line made of lightweight real carbon and aluminum alloy. It serves as an effective reservoir to collect oil that is introduced into the system and to prevent it from entering the intake. Turbocharged cars especially need an active way to remove crankcase vapors, and keeps the engine oil cleaner for a longer service interval.

Flange diameters:9mm/15mm



CT-045-1

CT-045-2

CT-045-3

CT-045-4

## ENGINE BAY STYLING KIT HOSE GUARD



ITEM NO.	COLOR	MSRP
HG-01-R		
HG-01-B		
HG-01-S		

## SIMOTA 4 POINT SEAT BELT HARNESS PAD

is designed as F4 racing seat, supporting the driver at the turn with maximum control. A must-be for high performance sports.



ITEM NO.	DESCRIPTION	NOTES
ESB-R	RED	e4 certified
ESB-B	BLUE	e4 certified
ESB-BK	BLACK	e4 certified



ITEM NO.	DESCRIPTION	NOTES
SB-R	RED	SGS approved
SB-B	BLUE	SGS approved
SB-BK	BLACK	SGS approved



ITEM NO.	DESCRIPTION
SBP-R	RED
SBP-B	BLUE
SBP-BK	BLACK



Note: 2 pieces per set





## OIL CAP



ITEM NO.	DESCRIPTION
OC-F	FORD / MAZDA
OC-H	HONDA
OC-M	MITSUBISHI
OC-N	NISSAN
OC-S	SUBARU
OC-T	TOYOTA
OC-LT	LADA- TOYOTA
OC-LS	LADA- SUBARU
OC-LM	LADA- MITSUBISHI
OC-SZ	SUZUKI SWIFT

• Available in: Red / Blue / Chrome

## ALUMINUM ALLOY ASHTRAY

Anodised Base With Laser Engraved Simota Logo



## SIMOTA SHIRT & CAP



SIZE	COLOR	MSRP
L	BK/	
2L	BK/WHITE	
3L	BK/WHITE	
4L	BK/	

Stainless-Steel / Nonwoven Fabric (Epoxy Resin)  
High-Flow Air Filter ~Select for the Market! OEM is available.

SIMOTA stainless-steel stock replacement air filter is renewable racing air-filter element, made of special stainless steel, with a unique EPDM frame. They stainless-steel mesh features 200 x200 mesh, and is corrugated to form air induction walls with depth of 18 – 25mm, ensuring to form the powerful air flow from out of the car effectively.

It increases surface area to promote air flow, and as a result, can increase engine horsepower by 7%. This air filter features high hardness, corrosion resistance, and cold / heat resistance, and is applicable under any climates and driving environments.

It ensures extended engine operating life, and will require no replacement at all. It only needs to be oiled with SIMOTA Air Filter Cleaner and Oil Kit once every 5,000 kilometers.

The stainless-steel air filter is suitable for long-term use and cost-effective.

SIMOTA's nonwoven fabric ( epoxy resin) stock replacement air filter greatly increases air intake volume and the air intake efficiency of engines.

It is designed for use of both non-oiled and oiled conditions, and is more dust-absorptive than original air filter models.

Our replacement air filter could extend engine operating life and smooth the air intake, also it increases horsepower by 5% at least. Customized and OEM air filters are available for clients.





**PRODUCT ANALYSIS**  
**Stainless-Steel / Nonwoven Fabric (Epoxy Resin)**  
**High-Flow Air Filter~ Select for the Market!**

It is designed for use of both non-oiled and oiled conditions, and is more dust-absorptive than original air filter models.  
 Our replacement air filter could extend extended engine operating life and smooth the air intake, also it increases horsepower by 5% at least.

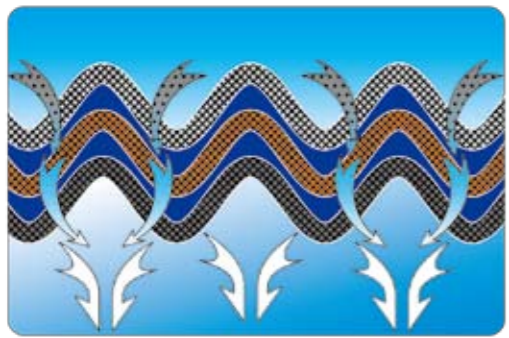

1. Made of unique EPDM frame
2. One-piece extrusion molded
3. Extremely lightweight
4. Strong structure



*Non-woven fabric element*

*Stainless steel (200 × 200mesh)*

**Strong galvanised steel mesh coated with epoxy**

**Non-woven fabric element**

**Stainless steel (200 × 200mesh)**

**Strong galvanised steel mesh coated with epoxy**

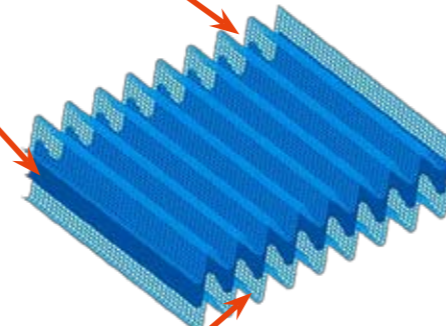
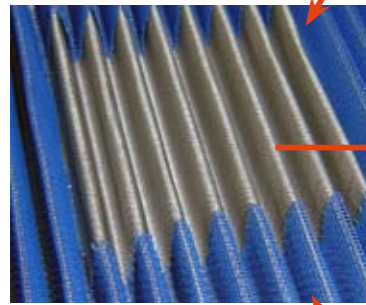

SIMOTA stainless-steel stock replacement air filter is renewable racing air-filter element, made of special stainless steel, with a unique EPDM frame. They stainless-steel mesh features 200 × 200 mesh, and is corrugated to form air induction walls with depth of 18 – 25mm, ensuring to form the powerful air flow from out of the car effectively.  
 It increases surface area to promote air flow, and as a result, can increase engine horsepower by 7%.  
 This air filter features high hardness, corrosion resistance, and cold / heat resistance, and is applicable under any climates and driving environments. It ensures extended engine operating life, and will require no replacement at all. It only needs to be oiled with SIMOTA Air Filter Cleaner and Oil Kit once every 5,000 kilometers.  
 The stainless-steel air filter is suitable for long-term use and cost-effective. SIMOTA's nonwoven fabric ( epoxy resin) stock replacement air filter can greatly increase air intake volume and the air intake efficiency of engines.



SIMOTA filters are made of light yet durable rubber compound and with better filtration surface for the same application.

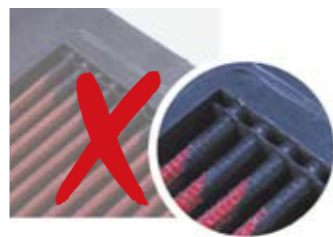

12mm-16mm rubber infringement of Manufacturer E significantly reduces the filtration area. Besides, the filter is obviously over-weight that adds excessive load to the car.



The filter of Manufacturer X is not one-piece extrusion molded. Due to the poor technology and the terrible structure, it may endanger the driving safety.

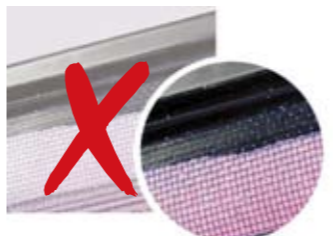

The exposed aluminum net significantly shows its poor quality. Manufacturer K's filter frame has fragile rubber structure...



The "X" brand's stainless steel air filter is attached with glue-on method in its production process. It can be easily peeled off after enduring of heat. IF the rubber piece falls off and caught in engine valve, the car will have difficulty to slow down in time. This could have resulted in severe damage and harm...



Poor rubber structure of Manufacturer K can be easily melts under engine heat which cause distortion therefore suffers from air leakage and resulted in inferior filtration.





**FOR AUDI**

Item NO.	Car Make	Engine	Year	Length x Width\note	MSRP			
OA001	A4	2.5L V6 DSL 155/164/180BHP TDI	00-05	263X210				
		1.6L L4 F/I	01-07					
		1.9L L4 DSL	01-07					
		2.0L L4 DSL	04-07					
		2.0L L4 F/I	00-08					
		1.8L L4 F/I	02-07					
		2.4L V6 F/I	02-08					
		3.0L V6 F/I	02-08					
		QUATTRO 1.8L L4 F/I	02-05					
		QUATTRO 3.0 V6 F/I						
		3.0L V6 DSL	04-07					
		2.7L V6 DSL	06-07					
		3.2L V6 F/I	05-09					
		QUATTRO 3.2L V6F/I						
		QUATTRO 2.0L L4 F/I						
	S4	4.2L V8 F/I	05-09					
	RS4	4.2L V8 F/I	07-09					
	CABRIOLET	3.0L V6 F/I	04					
	OA002	A6	2.0L L4 F/I	05-09	Round			
			2.0LL4 DSL	04-09				
OA003	A4	1.8L L4F/I / 2.0L L4F/I	07-10	321X127				
		2.0L L4 DSL						
	A5	1.8L L4F/I	09-10					
		2.0L L4F/I						
		2.0L L4 DSL						
Q5	2.0L L4F/I		08-10					
		2.0L L4 DSL						
	OV001	80	1.8L			82-86	338X135	
			1.9L			86		
			2.2L			86		
1.6L L4	82-91							
2.0L L4	88-92							
QUATTRO 2.3L L5	88-92							
90	1.6L		86-91					
	2.2L		87-91					
	QUATTRO 2.3L L5		88-91					
	2.3L		87					
Cabriolet	2.0 16v 140hp	95-00						
Coupe	1.8 93/107/112hp	85-88						
	2.0L	88						
	2.2L L5	81-88						
	Quattro 2.3L	88-91						
4000	1.6L L4	82-83						
	1.8L L4	85-86						
5000	2.0L L5	79-82						
	A3	1.4L L4 DSL	09-10					
		1.8/2.0L L4 F/I	06-10					
		2.0L L4 DSL	03-10					
		1.9L L4 DSL	04-10					
TT	2.0L L4 DSL	08-09						
OV011	TT	1.8L L4F/I	98-07	355x183				
		QUATTRO 1.8L L4F/I	00-06					
		QUATTRO 3.2L V6F/I	03-06					
	S3	1.8L L4F/I	98-03					
A3	1.6L L4F/I	96-03						
	1.8L L4F/I	96-03						
	1.9L L4 DSL-TDI	96-03						

Item NO.	Car Make	Engine	Year	Length x Width\note	MSRP	
OV004	A4	1.6L L4 F/I	94-01	254X213		
		1.8L L4 F/I	94-01			
		1.9L L4 DSL-TDI	94-00			
		2.6L V6 F/I 150BHP	94-01			
		2.8L V6 F/I	94-01			
		2.4L V6 F/I 165BHP	97-01			
		2.5L V6 DSL-TDI 150BHP	98-01			
		QUATTRO 2.8L V6 F/I	96-01			
		QUATTRO 1.8L L4 F/I	97-01			
		2.7L V6 F/I TWIN TURBO 5V	01-02			
		A6	1.8L L4 F/I			97-04
			1.9L L4 DSL-TDI			97-04
			2.0L L4 F/I 130BHP			97-05
			2.4L V6 F/I BHP			97-04
			2.7L V6 F/I			00-04
	2.8L V6 F/I		98-04			
	3.0L V6 F/I		02-04			
	4.2L V8 F/I 5V		00-04			
	2.5L V6 DSL-TDI 150BHP TURBO		97-01			
	QUATTRO 2.7L V6 F/I		00-04			
	Allroad	QUATTRO 2.8L V6 F/I SEDAN	98-04			
		QUATTRO 4.2L V8 F/I	00-04			
		QUATTRO 2.5L V6 DSL-TDI	99-04			
		QUATTRO 2.7L V6 F/I	01-05			
		QUATTRO 4.2L V8 F/I	03-05			
	S4	2.7L V6 F/I 265BHP	97-99			
		2.7L V6 F/I	00-02			
		RS4	2.7L V6 F/I BI-TURBO QUATTRO	00-03		
	S6	4.2 V8 F/I	02-04			
	OLD007	100	AUDI 100 2.2L F/I 20v Turbo	89-91	211X211	
			AUDI 100 2.2L F/I Turbo			
			AUDI 100 2.3L F/I			
			AUDI 100 2.3L L5 F/I			
		200	AUDI 200 2.2L F/I 20v Turbo	89-91		
			AUDI 200 2.2L F/I Turbo	90-91		
5000	AUDI 200 2.2L L5 F/I Turbo	89-91				
	AUDI 200 2.3L F/I	90-91				
	AUDI 5000 2.1L L5 F/I	78-83				
	AUDI 5000 2.2L F/I	78-81				
	AUDI 5000 2.2L L5 F/I	82				
	AUDI 5000 2.2L L5 F/I	84-87				
	AUDI 5000 2.2L L5 F/I Turbo	83				
AUDI 5000 2.2/2.3L L5 F/I Turbo	88					
AUDI 5000 2.3L F/I 5000T Turbo	83-85					
OV008	90	2.3 20v Quattro	90-91	309X185		
		100/200	1.9Tdi/2.0i/2.3i/2.6i			91-94
			2.2 Quattro 20v/2.8			89-94
			2.4D/2.5TDi			91-94
			2.5Dsl			89-94
	S6	2.0/2.2i Turbo	95			
	Cabriolet	2.6 V6 139hp	95-00			
		2.8 174hp	92-00			
		2.5 TDi	94-97			
	A6	2.5 TDi	99-97			
2.5 TDi 180hp Allroad		00-97				
2.6/2.8 V6		94-97				
2.8 30v 193hp Quattro		95-97				

**FOR AUDI**

Item NO.	Car Make	Engine	Year	Length x Width\note	MSRP	
OV010	4000	1.8	84	274X134		
		Fox	1.5			73
		1.6	74-79			
OV012	80	2.0L L4	91	310X235X55\Oval		
		1.3L CARB	83-86			
		1.6L CARB	75-83			
		100/200	1.8L CARB			81-90
		1.9L CARB	80-90			
		1.6L CARB	76-82			
	Fox	1.5L CARB	73-74			
	OV017	A3	2.0L L4 F/I(TURBO)			04-08
		TT	2.0L L4 F/I			06-09
	OV-002	A3	1.4L L4 F/I			05-10
1.6L L4 F/I			03-10			
2.0L L4 F/I(TURBO)						

**FOR ACURA**

Item NO.	Car Make	Engine	Year	Length x Width\note	MSRP
OH004	CL	2.3L L4 F/I	97-99	316x184\Irregular	
OFR005 (Round)	RSX/RSX Type-S	2.0L L4 F/I	02-07	157x18x31\Round	
OH009	TSX	2.4 L4 F/I	04-08	337x148\Rhombus	
OH-020	TL	3.5 L4 F/I	09-10	260x203	
		3.7 L4 F/I			

**FOR ALFA ROMEO**

Item NO.	Car Make	Engine	Year	Length x Width\note	MSRP			
OFI002	145	1.4L L4 F/I	97-01	248X167				
		1.6L L4 F/I	97-01					
		1.8L L4 F/I	97-01					
		2.0 L4 F/I	98-01					
		1.9L L4 DSL	99-01					
		146	1.4L L4 F/I			97-01		
			1.6L L4 F/I			97-01		
			1.8L L4 F/I			97-01		
			2.0L L4 F/I			95-01		
			1.9L L4 DSL			99-01		
	155	1.6L L4 F/I	96-97					
		1.8L L4 F/I	96-98					
			2.0L L4 F/I 16V TURBO			95-97		
	OT009	145	1.9L L4 DSL			94-97	246X119	
		146	1.9L L4 DSL			94-97		
OAR001	147	1.9 JTD 101hp	03-08	295x162				
		1.9 JTDM 8V 120hp	05-08					
		1.9 JTDM 16V 150hp	05-08					
		1.9 JTD 16V 126hp	03-04					
		1.9 JTDM 16V 115hp	04-08					
		1.9 JTD 16V 136hp	04-08					
		1.9 JTD 16V 140hp	02-08					
		GT	1.9 JTD 16V M-jet 150hp			04-08		

**FOR BMW**

Item NO.	Car Make	Engine	Year	Length x Width\note	MSRP				
OV004	Alpina B3	3.0	93-95	254X213					
		3.2	96-00						
		E39 535	235hp			96-04			
		E39 540i	4.4 V8						
		E39 M5	400hp V8			98-04			
		E34 530	218hp V8			92-96			
		E34 540	286hp V8			92-95			
		E23/E32/E38/E65	3.5i 235hp			96-on			
		730	4.0L V8 F/I			94-01			
		735	3.5L L6 F/I						
		740	286hp V8						
		E31 830	218hp V8			92-on			
		Z8	4.9i 400hp V8			00-on			
		OB001				325i	2.5L L6 F/I -E30	83-93	258X149
						325E	2.7L L6 F/I	86-88	
325iX	2.5L L6 F/I			86-96					
325iS	2.5L L6 F/I			87-91					
320i	2.0L L6 F/I			85-93					
318i	1.8L L4 F/I			87-95					
318iS	1.8L L4 F/I			89-94					
316i	1.6L L4 F/I			87-95					
520i	2.0L L6 F/I			85-88					
520i	2.0L L6 F/I -129BHP			89-91					
525E	2.7L L6 F/I			85-87					
528E	2.7L L6 F/I			86-88					
525i	2.5L L6 F/I - 170BHP			89-90					
525i	2.5L L6 F/I - 192BHP			91-					
525i	2.5L L6 F/I - US			89-91					
518i	1.8L L4 F/I	89-95							
750i	5.0L V12 F/I	87-94							
	(2required)								
750iL	5.0L V12 F/I	87-94							
	(2required)								
850i	5.0L V12 F/I	90-94							
	(2required)								
850Ci	5.0L V12 F/I	93-94							
	(2required)								
850Ci	5.6L V12 F/I	95-							
	(2required)								
850CSI	5.0L V12 F/I	93-94							
	(2required)								
850Ci	5.4L V12 F/I	95-99							
	(2required)								
Z1	2.5L L6 F/I	88-91							
OB002		318i	1.8L L4 F/I	95-99	230X234				
		318i	1.9L L4 F/I	96-98					
		318iC	1.8L L4 F/I	95-97					
		318iC	1.9L L4 F/I	96-97					
		318iS	1.8L L4 F/I	94-97					
		318iS	1.9L L4 F/I	95-99					
		318Ti	1.8L L4 F/I	94-95					
		318Ti	1.9L L4 F/I	95-00					
		316i	1.6L L4 F/I	95-00					
		Z3	1.8L L4 F/I	95-98					
Z3	1.9L L4 F/I	95-03							



## FOR BMW

Item NO.	Car Make	Engine	Year	Length x Width/Note	MSRP			
OB003	E36 325	2.5L L6 F/I	91-99	240X178				
	E36 323i	2.5L L6 F/I	90-99					
	E36 320	2.0L L6 F/I	90-99					
	E36 M3	3.0L L6 F/I	92-99					
		3.2L L6 F/I	95-99					
	728	2.8L L6 F/I	94-01					
	E39 528	2.5L L6	95-96					
	E34 523	2.5L L6	96-00					
	E39 528	2.8L L6	97-00					
	E39 520	2.2L L6	00-04					
	E39 520i	2.0L L6	96-04					
	E39 525i	2.5L L6	00-04					
	E39 530i	3.0L L6	00-04					
	Z4	2.2L L6	03-05					
		2.5L L6						
		3.0L L6						
	Z3	2.2L L6	00-04					
		2.5L L6	99-04					
		2.5L L6	98-04					
		3.0L L6	00-04					
		3.2L L6	97-03					
		2.8L L6	97-00					
		2.0L L6	99-00					
	E46 316	1.6L L4	99-01					
	E46 318	1.8L L6	99-01					
	E46 320	2.0L L6	98-06					
	E46 323	2.5L L6	00-06					
	E46 330	3.0L L6	01-06					
	E46 325	2.5L L6	01-06					
	M3	3.2L L6	01-07					
	X3	2.5L L6	04-06					
	OH008	E34 520	2.0L L6 24V			90-96	327X145	
		E34 525	2.5L L6 24V					
OB004	116i	2.0L L4 F/I	04-10	round				
	118i							
	120i							
	316i							
	318i							
	320i							
	320Si					2.0L L4 F/I	06-08	
OB005	116D	2.0L L4 DSL	09-10	292X232				
	118D		07-10					
	120D							
	123D							
	318D							
	320D							
	316D		09-10					
	X1		09-10					
	330D		3.0L L6 DSL			09-10		
	335D					05-10		

Item NO.	Car Make	Engine	Year	Length x Width/Note	MSRP					
OB006	118D	2.0L L4 DSL	04-07	292x232 Oval						
			120D							
			318D			00-07				
			320D			98-07				
			320TD			01-05				
			320CD			03-05				
			X3			04-07				
			520D			05-07				
			OB007			325D	2.5L L6 DSL	06-10	Oval	
								330D		
330XD										
520D	2.0L L6 DSL	00-04								
525D	2.5L L6 DSL	00-10								
530D	3.0L L6 DSL	98-10								
730D										
X3		04-08								
X5		00-10								
X6		08-10								

## FOR CADILLAC

Item NO.	Car Make	Engine	Year	Length x Width/Note	MSRP
OV013	CTS-V	5.7 V8 F/I	04-05	273x183	
		6.0 V8 F/I	06-07		

## FOR CHRYSLER

Item NO.	Car Make	Engine	Year	Length x Width/Note	MSRP	
OH012	300M	3.5 V6 F/I	99-04	241x188		
		Concorde	2.7 V6 F/I			98-04
			3.2 V6 F/I			98-02
			3.5 V6 F/I			02-04
OV010	Voyager	2.4 151hp	95-on	274X134		
		2.5TD	95-on			
		3.0	88-90			
		3.0	91-95			
		3.3 V6 163hp	96-on			
		Landau	3.0			89
		Lancer	2.2 XE			85
			2.2 non-turbo			84-85
			2.2 Turbo			84-86
			Le Boron			3.0
New Yorker	2.2 non-turbo	85				
	2.2 Grand	84				
	3.0 Salon	91				
	3.3 exc Landan	90				
	3.0	88-89				
	2.2 non-turbo	85				
TC	2.2	84				
	2.2 turbo	91				
	3.0	90-91				

## FOR CITROEN

Item NO.	Car Make	Engine	Year	Length x Width/Note	MSRP				
OC001	Saxo	1.6L L4 F/I 8V	99-03	304X115					
OC002	BERLINGO	1.6L L4 F/I	00-07	333X100					
		1.4L L4 F/I	02-07						
		1.1L L4 F/I	02-06						
		1.6L L4 F/I	02-09						
		1.4L L4 F/I	02-09						
		1.1L L4 F/I	02-09						
		1.6L L4 F/I	03-09						
		1.4L L4 F/I	03-09						
		1.1L L4 F/I	03-09						
		OP001	XSARA			2.0L L4 DSL	99-06	207X170	
						1.9L L4 DSL	01-04		
						2.0L L4 F/I 136BHP	00-05		
						1.6L L4 F/I	01-05		
1.4L L4 F/I	01-05								
1.4L L4 F/I 8V	00-04								
2.0L L4 DSL	99-06								
3.0L V6 210BHP 24V	03-								
2.0L L4 F/I	03-06								
1.8L L4 F/I	00-06								
1.6L L4 F/I	00-05								
2.0L L4 DSL	02-05								
OP002	C4			1.6 16V L4 F/I	04-08	421x94			
		XSARA PICASSO	1.6L L4 F/I	05-09					
		BERLINGO	1.6L L4 F/I	08-09					
OM009	C-CROSSER	2.4L L4 F/I	07-10	270x185					
OT009	C1	1.0L L3 F/I	05-10	258X115					
OC004	C3	1.4L L4 DSL 8V	02-09	281x140					
		1.4L L4 DSL	03-09						
		1.4L L4 DSL	05-08						
		XSARA	1.4L L4 DSL			05			
		NEMO	1.4L L4 DSL			07			

## FOR CHEVROLET

Item NO.	Car Make	Engine	Year	Length x Width/Note	MSRP		
OCH-001	AVEO	1.2L L4 F/I	05-10	223X187			
		1.4L L4 F/I					
		1.6L L4 F/I					
		KALOS				1.4L L4 F/I	04-09
						1.2L L4 F/I	04-09
ON003	Nova/Chevy II	1.6L L4 F/I	88	228x166			
OS003	TRACKER	1.6L/2.0L L4	99-00	228X199			
		2.0L L4/2.5L V6	01-04				
OBU-001	OPTRA	1.6L L4 F/I	03-05	302X222			
		1.8L L4 F/I					
		LACETTI				1.4L L4 F/I	05-10
						1.6L L4 F/I	05-10
						1.8L L4 F/I	05-08
	NUBIRA	1.4L L4 F/I	05-08				
		1.6L L4 F/I	05-10				
		1.8L L4 F/I	05-10				

## FOR DAEWOO

Item NO.	Car Make	Engine	Year	Length x Width/Note	MSRP
ODA001	MAGNUS	2.0L L4	01-07	277X247	
OKR003	MATIZ	800/1100	03-08	198x190	
OCH-001	KALOS	1.2L L4 F/I	03-04	223X187	
		1.4L L4 F/I			

## FOR DAIHATSU

Item NO.	Car Make	Engine	Year	Length x Width/Note	MSRP	
ON003	Applause	1.6L F/I	90	228x166		
		Charade	1.0L L3 F/I 12v			93
			1.6L F/I 16v			
			1.3L L4 F/I			88-92
			1.0L L3 F/I			
			1.3L F/I 16v			88
			1.0L L3 Dsl turbo			87
			1.0L L3 F/I turbo			
	Grand Move	1.5L L4	97			
OO001	Charade	1.0L L3 Dsl	84-87	213X167		
		1.0L L3 F/I Turbo				
OT009	SIRION	1.0L L3 F/I	05-10	246X119		

## FOR DAIMLER

Item NO.	Car Make	Engine	Year	Length x Width/Note	MSRP
OLD007	SOVEREIGN	2.9/3.6 F/I	86-89	211X211	
		4.0L L6 DOHC	90		
		4.0L L6 F/I	93-03		
		DOUBLE SIX	6.0L V12 F/I		

## FOR DODGE

Item NO.	Car Make	Engine	Year	Length x Width/Note	MSRP	
OH012	Intrepid	2.7 V6 F/I	98-04	241x188		
		3.2 V6 F/I	98-02			
		3.5 V6 F/I	00-on			
OM001	Colt	1.5 L4 F/I	93-95	221X201		
		1.8 L4 F/I				
OV010	600	2.2 non Turbo	85	274X134		
		2.2	84			
		Carran	3.0			87-95
		Daytona	2.2			93
			3.0			90-93
			2.2 Turbo			92
			3.0 Shelby			91
			2.2 non Turbo			84-85
		Dynasty	3.0			88-93
		Lancer	2.2			85
		Monaco	3.0			91-92
		Omni	2.2			88-90
		Shadow	3.0			92-94
		Spirit	2.2 Turbo			89-95
			2.5 Flex Fuel			91-92
			2.5 Turbo			94
			3.0			93





**FOR EAGLE**

Item NO.	Car Make	Engine	Year	Length x Width>Note	MSRP
OM001	Summit	1.5L L4 F/I	93-96	221X201	
	93-96 -	1.8L L4 F/I			

**FOR FERRARI**

Item NO.	Car Make	Engine	Year	Length x Width>Note	MSRP
OT007	F355	3.5L V8 F/I	94	318X193	
	456M	5.5L V12 F/I	93		
	550	5.5L V12 F/I	93-95		
	F40	3.0L V8 F/I	88-92		

**FOR FIAT**

Item NO.	Car Make	Engine	Year	Length x Width>Note	MSRP
OFI001	Punto I 90	1.6	94-99	378X139	
	Punto I GT	1.4 Turbo			
OFI002	Bravo	1.2 16v 82hp	98-01	248X167	
		1.4 16v 80hp	95-01		
		1.6 16v 103hp	96-01		
		1.6/1.8 16v 90hp	95-01		
		1.9 D			
		1.9 JTD	98-01		
		1.9 TD 75/100hp	96-01		
		1.9 Turbo Dsl	95-01		
		2.0 HGT/HGT 20v			
		2.0 HGT/HGT 20v			
	Brava	1.2 16v 82hp	98-01		
		1.4/1.6/1.8 16v	95-01		
		1.6 16v 103hp	96-01		
		1.9 D	95-01		
		1.9 JTD	98-01		
	Marea/Weekend	1.9 TD 75/100hp	96-01		
		2.0 HGT 5cyl 20v 147hp	95-01		
1.4, 1.6, 1.8 16v		95-01			
2.0 HGT 20v		96-02			
	75/100/125hp TD				
	1.6/1.8/2.0 F/I	97-02			
	1.9/2.4 Dsl TD Turbo				
	1.9/2.0 L4 F/I	95			
OFI003	IDEA	1.3JTD 70HP	04-08	375x145	
	PANDA II	1.3JTD 70HP	03-09		
	PUNTO II	1.3JTD 16V 70HP	03-05		
	PUNTO III/GRANDE	1.3D Multijet 75HP	05-09		
	PUNTO III/GRANDE	1.3D Multijet 90HP	05-09		
	DOBLO	1.3L L4 DSL	04-09		
	ALBEA		04-07		
	STRADA		06-09		
	LINEA		07-09		
	FIORINO				
	500				

Item NO.	Car Make	Engine	Year	Length x Width>Note	MSRP	
OFI004	STILO	1.2L L4 F/I 16V	01-06	325X154		
		1.4L L4 F/I	04-06			
	PUNTO	1.4L L4 F/I	03-05			
	GRANDE PUNTO	1.4L L4 F/I 16V	05-08			
	IDEA	1.2L L4 F/I	04-07			
		1.4L L4 F/I				
	PANDA II	1.4L L4 F/I	06-09			
	BRAVO	1.4L L4 F/I-exc TURBO	07-10			
	500	1.4L L4 F/I	07-10			
	OFI005	GRANDE PUNTO	1.2L L4 F/I			05-10
1.4L L4 F/I 8V						
	500	1.2L L4 F/I	07-10			
OT009	Tipo	1.4L Carb	88	246X119		
		1.4L F/I	93			
		1.6L Carb	88			
		1.6L F/I	93			
		1.6L F/I AGT Inj	89			
		1.7L F/I 16v	89			
		1.7L DSL - Eco Diesel	93			
		1.8L F/I AGT 16V DOHC	90			
		1.9L Dsl Eco Diesel	93			
		1.9L Dsl Turbo Intercooler	89			
		2.0 F/I 16v	92-95			
		Tipo Abarth	2.0 F/I 16v			89
		Uno	1.3L F/I Turbo			93
			1.5L F/I Selecta			
Tempira	1.4/1.6/1.8/1.9/2.0	90				
	1.6 F/I	93				
OLD007	GRANDE PUNTO	1.9L L4 DSL	05-08	211X211		
OO007	GRANDE PUNTO	1.4L L4 F/I Turbo	07-09	203x211		

**FOR FORD**

Item NO.	Car Make	Engine	Year	Length x Width>Note	MSRP
OFO001	Liata	1.6/1.8	93-99	244x157	
	Activa	1.6	98-02		
	Tierra	1.6/1.8/2.0	98-04		
	Aztec	1.6/1.8	95-97		
OFO002	Telstar	2.0/2.5 V6	92-98	256x164	
OFO003	Mondeo	1.6/1.8/2.0	93-01	395x149	
	Contour	2.0 L4 F/I	95-00		
OFO004	Focus	1.4/1.6/2.0 L4 F/I	98-04	264x148	
		1.6/2.0			
		1.8 L4 Dsl			
		1.8 L4 F/I			
	Focus SVT/ST170	2.0 L4 F/I	02-04		
OFO005	Fiesta	1.2/1.4 16V	95-98	259x179	
		1.3 L4 F/I 8v	95		
		1.8 DSL	95		
		1.3 8V	95-98		
		1.8 Diesel	95-00		

**FOR FORD**

Item NO.	Car Make	Engine	Year	Length x Width>Note	MSRP			
OFO005	PUMA	1.4 F/I 16v	98	259x179				
		1.7 L4 F/I 16v	97					
	ESCAPE	2.0 DOHC 16V	01-04					
		2.3L L4 F/I	05-10					
		2.5L L4 F/I	09-10					
		3.0 V6 DOHC 24V	01-10					
		3.0L L4 F/I	01-05					
	MAVERICK	3.0L L4 F/I	01-05					
	OFO006	Metrostar	2.0/2.5 V6			01-03	336x143	
		Mondeo	1.8			00-03		
2.0 L4 F/I			01					
2.0 L4 TDI			00-03					
		2.5/3.0 V6 F/I 24v						
OT003	Probe	2.0L L4 F/I	93-97	267X169				
OV010	Escort	1.6	83-84	274X134				
	EXP	1.6 Turbo	86-87					
OFO007	FOCUS	1.8/2.0L L4 F/I	04-07	275X187				
		1.6L L4 F/I	03-07					
		1.8L L4 F/I						
		2.0L L4 F/I						
OFO008	FALCON	5.7 V8 EL	00	293X230				
OFO009	FALCON	4.0 V6 F/I	03-07	305X240				
OFO010	FOCUS	1.8/2.0 DOHC 16V F/I	08-10	Round				
		2.0L L4 DSL						
		2.0L L4 DSL						
	KUGA	2.0L L4 DSL						
OFO011	MONDEO	2.3L L4 F/I	08-10	300X237\Rhombus				
	MONDEO TDI	2.0L L4 DSL	08-10	300X237				
OFO012	FUSION	1.25L L4 F/I	04-07	216X165				
		1.4L L4 F/I	02-10					
		1.6L L4 F/I						
		1.25L L4 F/I	02-08					
	FIESTA	1.3L L4 F/I						
		1.4L L4 F/I						
		1.6L L4 F/I						
		1.6L L4 F/I						
OFO013	FIESTA VI	1.25L L4 F/I	08-10	200X162				
		1.4L L4 F/I						
		1.6L L4 F/I						
		1.6L L4 F/I DSL						
OT014	RANGER	2.5L L4 DSL	06-08	Round				
		3.0L L6 DSL	06-08					
OC004	FUSION	1.4L L4 DSL	02-07	281X140				
		FIESTA	1.4L L4 DSL			02-10		
OFI003	KI	1.3L L4 DSL	09-10	375x145				

**FOR GEO**

Item NO.	Car Make	Engine	Year	Length x Width>Note	MSRP
OD002	Prizm GSI	1.6L L4 F/I	90-92	251X157	
OT005	Prizm	1.6/1.8 L4 F/I	94-97	269X172	

**FOR HYUNDAI**

Item NO.	Car Make	Engine	Year	Length x Width>Note	MSRP	
OHY001	MATRIX	1.6/1.8 L4 16V DOHC	04-09	240X190		
		1.5L L4 DSL	01-08			
OHY006	GETZ	1.1 / 1.6L L4 F/I	02-08	235X123		
		1.3L L4 F/I	02-05			
		1.5L L4 DSL	03-07			
OHY002	SANTA FE	2.7L V6	01-06	255X175		
		2.4L L4	01-04			
	TUCSON	2.0/2.7	05-09			
OHY003	XG	2.5L V6	99-04	238X190		
		SONATA	2.0L L4/2.5L V6			99-01
		SONATA	2.4L L4/2.7L V6			02-05
		TRAJET	2.0L L4/2.5L V6			00-04
OHY004	NF SONATA	2.0-2.5	06-on	237x189		
OHY005	ELANTRA	1.6L/2.0L L4	01-07	253X175		
		TUCSON	1.6L/2.0L L4			02-09
			2.7L V6			
		TIBURON	2.0L L4			03-08
		2.7L V6				
	COUPE	2.0L L4	02-09			
		2.7L V6				
OHY007	I30	1.4L L4 F/I	07-10	198X184		
		1.6L L4 DSL				
		1.6L L4 F/I				
		2.0L L4 DSL				
		2.0L L4 F/I				
	AVANTE	1.6L L4 F/I	07-10			
	ELANTRA	2.0L L4 F/I	07-10			
OHY008	AZERA	3.3L V6 F/I	07-10	235X205		
		3.8L V6 F/I	06-10			
		SONATA	3.3L V6 F/I			05-10
		GRANDEUR	3.3L V6 F/I			05-09
OHY009	GENESIS	3.8L V6 F/I	09-10	Bevel edge		
OT005	NEW SANTA FE	2.0	06-on	268*175		
OV-010	ACCENT	1.4L L4 F/I	05-09			
		1.6L L4 F/I	06-10			

**FOR HOLDEN**

Item NO.	Car Make	Engine	Year	Length x Width>Note	MSRP
OCO001	COMMODORE	3.8L V6 F/I VT.VX.VY	97-04	290X227	
		5.0/5.7L V8F/I			
OFO008		5.7L V8F/I	00-01	293X230	
ON001		3.8L V6 F/I VS.VR	97-04	280X168	



**FOR HONDA**

Item NO.	Car Make	Engine	Year	Length x Width\note	MSRP	
OFR005 (Round)	Integra Type-R	2.0L L4 F/I	01-05	157X18X31 Round		
	Civic Si	2.0L L4 F/I	01-05			
	CIVIC VI	2.0L L4 F/I	01-05			
	CR-V	2.0L L4 F/I	02-06			
	CR-V	2.4L L4 F/I	02-06			
	FR-V	2.0L L4 F/I	05-08			
	Stream	2.0L L4 F/I	01-05			
OH001	Civic V	1.4L L4 F/I	95	209x186		
		1.5 DXi(EH9) 16v	92-95			
		1.5 ESi(EG5) 16v				
		1.5 LSi(EG4) 16v				
		1.5 ILS(EG4) 16v	91-95			
		VTi(EG6/EG9)				
		1.5/1.6 L4 F/I	91-95			
		1.6 iLS(MB1) 16v	92-95			
		1.6(AE) Vtec	91-93			
		1.8L L4 F/I	97			
	CRX	1.6L L4 F/I	91			
	Del Sol	1.6 L4 F/I	96-97			
	OH002	CIVIC	1.5 L4 F/I	96	201X193	
			1.6 L4 F/I	96-00		
Civic IV		1.5iLS(MB1) 16v	88-91			
		1.6i(ED) 16v	87-91			
		1.6i(ED7)				
		1.6iGL(ED4)				
Civic V		1.5 8v VTec (EH6)	95-01			
Civic VI		1.5 iLS 16v VTec (EJ2)	96-01			
CIVIC SI / HX / GX / EX		1.6 L4 F/I	99-00			
CR-V		128hp (RD1)	98-01			
	2.0 L4 F/I	97-01				
	2.0 16v VTec 150hp	01-02				
HRV	1.6 L4 F/I	98-05				
OH003	Civic SI / LX / HX / DX / GX / EX	1.7 Ferio VTX/ES	01-05	314X195		
		1.7 L4 F/I				
OH004	Accord	2.0L L4 F/I	94-98	306X181 Irregular		
		2.2L L4 F/I	94-97			
		2.3L F/I				
	Shuttle	2.2L L4	95-98			
		2.3L L4 F/I	98-01			
	ODYSSEY	2.2L L4 F/I	95-97			
		2.3L L4 F/I	98			
OH005	Accord	1.6i 16v 108hp	99-01	274X167		
		1.8i ES 16v VTec 136hp	99-03			
		2.0i ES 16v VTec 147hp				
		2.2i VTec R 212hp				
		2.3 L4 F/I	98-02			
		2.3 16v	01-02			
OH006	City	1.5	93-01	222x165		
OH007	JAZZ/FIT	1.2L L4 F/I OE FILTER 17201-PWA010	01-08	332x108		
		1.4L L4 F/I OE FILTER 17201-PWA010	01-08			
		1.5L L4 F/I -ALL	05-08			

Item NO.	Car Make	Engine	Year	Length x Width\note	MSRP
OH008	Accord	2.4 L4 F/I (TAIWAN)	03-07	327X145	
		3.0 V6 F/I	03-07		
OH009	Accord	2.0/2.0i	03-08	337x148 Rhombus	
		2.4L L4 F/I (US)	03-07		
OH010	JAZZ/FIT	1.4L L4 F/I OE FILTER 17220-REAZ00	01-08	217x134 Rhombus	
		1.2L L4 F/I OE FILTER 17220-REAZ00	01-08		
		1.5L L4 F/I-ALL	05		
OH011	Accord	2.0L/2.2L L4 F/I	89-93	245X136	
		2.3L L4 16V F23A2	93-94		
		2.0L L4 -F20Z ENG	95-98		
		2.2L L4-F22A ENG	96-98		
OH012	New Odyssey	2.4L	04-on	244x181	
OH013	JAZZ GD1 LT3A	1.4L	04-08	167X143	
OH014	Stream	1.7L L4 F/I	01-05	315X198	
		CIVIC	1.4L/1.6L L4 F/I		01-05
		FR-V	1.7L L4 F/I		05-08
ON003	Civic	1.4L L4 F/I	91-95	228x166	
		1.6L L4 F/I	96-99		
		1.8L L4 F/I VTEC	97		
OH015	CIVIC VIII	1.8L L4	06-10	225X195 Singapore	
		Stream	1.8L L4		07-10
OH016	CIVIC VIII	2.0L L4	06-10	276X157 Singapore	
OH017	CRV	2.0L L4	07-10	260X170 Rhombus	
OH018	FIT/JAZZ	1.3L L4	08-10	172x167	
OH019	ACCORD	2.4	08-10	273X219	
OH020	ACCORD	3.5	08-10	260X203	
OH021	CRV	2.4L L4 F/I	07-10	266X170 Rolygon	

**FOR INFINITI**

Item NO.	Car Make	Engine	Year	Length x Width\note	MSRP
ON001	FX35	3.5 V6 F/I	03-08	280X168	
		G20	2.0 L4 F/I		91-02
		G35	3.5 V6 F/I		03-07
		I30	3.0 V6 F/I		93-02
		I35	3.5 V6 F/I		02-03
		J30	3.0 V6 F/I		93-97
		M30	3.0 V6 F/I		90-93
		Q45	4.1 V8 F/I		01
		QX4	3.3 V6 F/I		97-00
		QX4	3.5 V6 F/I		01-03

**FOR ISUZU**

Item NO.	Car Make	Engine	Year	Length x Width\note	MSRP
OH004	Oasis	2.2L L4 F/I	96-97	306 X 181 \	
		2.3L L4 F/I	98-00		Irregular
ON001	Pickup	2.2 L4 Dsl	86-87	280X168	
		Gemini	1.5/1.7 Dsl		85
OI001	D-MAX	2.5/3.0 Dsl	01-on	Round	

**FOR JAGUAR**

Item NO.	Car Make	Engine	Year	Length x Width\note	MSRP
OLD007	XJ	2.9/3.2/3.6L F/I AJ40	86	211X211	
		4.0L F/I turbo AJ40			
		6.0L V12 F/I	93		
	XJ6	2.9/3.0 L6 F/I	86		
		3.6L L6 F/I	86-89		
		4.0L L6 F/I	86-95		
	XJR	3.2L L6 F/I	90-02		
		JAGUAR XJR 3.6L L6 F/I sport	88		
	XJS	JAGUAR XJR 4.0L sport	89		
		JAGUAR XJS 6.0L V12 F/I	93		
	XJS 4.0L L6 F/I	91			

**FOR KIA**

Item NO.	Car Make	Engine	Year	Length x Width\note	MSRP	
OO002	Sorento	3.5 V6 F/I	03-04	299X239		
OK001	SEDONA	2.9L L4 DSL	01-02	303X195		
		CANIVAL	2.9L L4 DSL		01-08	
OK002	SORENTO	2.4L V6	02-06	297X236		
		2.5L L4 DSL	02-08			
		3.3L V6 F/I	06-09			
		3.5L V6 F/I	07-09			
OHY003	OPTIMA	2.4L L4/2.5L 2.7L V6	01-on	238X190		
OK005	EURSTAR	1.0/1.1L L4	04-09	251X113 Singapore		
		PICANTO	1.0/1.1L L4		04-09	
OHY002	CERATO	1.6L L4 F/I	04-06	255X175		
		2.0L L4 F/I				
		2.0L L4 DSL				
		1.5L L4 DSL			05-06	
		SPECTRA			2.0L L4 F/I	05-09
		SPORTAGE			2.0L L4 F/I	05-09
OHY007	CEE' D	1.4L L4 F/I	07-10	203X191		
		1.6L L4 F/I				
		2.0L L4 F/I				
		2.0L L4 DSL				
		1.5L L4 DSL			05-06	
		SPECTRA			2.0L L4 F/I	05-09
		SPORTAGE			2.0L L4 F/I	05-09
OK006	SEPHIA	1.8L L4 F/I	95-02	335X169		
		SHUMA	1.8L L4 F/I		97-02	
			1.5L L4 F/I		98-01	
			1.6L L4 F/I		01-04	
	SPECTRA	1.8L L4 F/I	00-04			
	CARENS	2.0L L4 DSL	02-06			

**FOR LADA**

Item NO.	Car Make	Engine	Year	Length x Width\note	MSRP
OLD007	NIVA	1.7L L4 F/I	00-08	211x211	

**FOR LANCIA**

Item NO.	Car Make	Engine	Year	Length x Width\note	MSRP
OFI002	Y10	1.4 F/I	95	248X167	
OT009	Delta	1.9L L4 Dsl Turbo	95	246X119	
		2.0 Dsl Turbo	94		
	Dedra	1.8 IE	89-94		
		2.0L F/I	90-94		
		1.9L Dsl turbo	89		
	2.0L F/I				
	2.0L Turbo				
OFI003	MUSA	1.3 DSLMultijet 70HP	04-08	375x145	
		YPSILON	1.3JTD		03-09
OFI004	YPSILON	1.2L L4 F/I 16V	03-07	325X154	
		1.4L L4 F/I 16V			
		MUSA			1.4L L4 F/I 16V
		1.2L L4 F/I 16V	06-07		

**FOR LAVERDA**

Item NO.	Car Make	Engine	Year	Length x Width\note	MSRP
OV014	SPORT	650	95-97	198X92	
		GHOST	650		95-97
		FORMULA	650		95-97
		668	650		95-97

**FOR LEXUS**

Item NO.	Car Make	Engine	Year	Length x Width\note	MSRP
OV008	ES300	3.0L V6 F/I	97-01	309X185	
		RX300	3.0L V6 F/I		99-03
OT011	LX450	4.5L L6	96-97	173X148mm Round	
OT016	IS220	2.2L L4 DSL	05-09	240X237	
		IS250	2.5L V6 F/I		05-10
		IS350	3.5L V6 F/I		06-10
		GS350	3.5L V6 F/I		06-09
		GS430	4.3L V6 F/I		06-07
OT007	ES300	3.0L V6 F/I	02-03	318X193	
		ES330	3.3L V6 F/I		03-06
		RX330	3.3L V6 F/I		03-06
		RX350	3.5L V6 F/I		06-09

**FOR LAND ROVER**

Item NO.	Car Make	Engine	Year	Length x Width\note	MSRP
B-006	FREELEANDER	2.0L L4 DSL	00-06	211x211	

**FOR LOTUS**

Item NO.	Car Make	Engine	Year	Length x Width\note	MSRP
OT004	ELISE	1.8L L4 F/I TOYOTA ENG	04-07	289X148	



**FOR MAZDA**

Item NO.	Car Make	Engine	Year	Length x Width>Note	MSRP
OFO001	323	1.5/1.8/1.9 L4 F/I	94	244x157	
	MP3	2.0 L4 F/I	02		
	Protégé/Isamu	1.5 L4 F/I	95-98		
		1.6 L4 F/I	99-03		
		1.8 L4 F/I	95-01		
	Premacy/Mav	2.0 L4 F/I	01-03		
1.8/2.0		01-08			
2.0 L4 F/I		98-02			
OFO002	626	2.0 L4 F/I	98-02	256x164	
OMA001	Mazda 6	1.8 L4 F/I	03	315X172	
		2.0 L4 F/I Turbo Dsl	02-03		
		2.3 L4 F/I	03-08		
		2.5 L4 F/I	09-10		
	626	2.0 L4 Turbo Dsl	98-02		
	MPV	2.5 V6 F/I	00-01		
OMA002	3	2.0/2.3 L4 16V	04-10	275X187	
		2.5 L4 16V	10		
	5	2.0L L4 16V	05-10		
		2.0L L4 DSL			
OMA003	3	1.4 L4 16V	03-08	313X198	
		1.6 L4 16V	04-10		
	2	1.3L L4 F/I	07-10		
		1.5L L4 F/I			
OFO005	121	1.2 F/I	96	259X179	
		1.8 DSL	96		
	TRIBUTE	3.0L V6 24V	01-08		
		2.5L L4 F/I	09		
		2.3L L4 F/I	05-08		
		2.0L L4 16V	02-05		
OT003	MX-6	2.0L L4 F/I	93-97	267X169	
		2.5L V6 F/I			
	626	2.0L L4 F/I			
OT005	Millenia	2.3L V6 F/I	95-02	269X172	
OC004	2	1.4L L4 DSL	03-07	281X140	
OFO-012	2	1.25L L4 F/I	04-07	216X165	
		1.4L L4 F/I			
		1.6L L4 F/I			

**FOR MERCURY**

Item NO.	Car Make	Engine	Year	Length x Width>Note	MSRP
OFO003	Cougar/XR7	2.0 L4 F/I	98-00	395x149	
OFO005	MARINER	2.0 L4 F/I	95-00	259X179	
		2.3/3.0 L4 F/I	05-08		

**FOR MERCEDES BENZ**

Item NO.	Car Make	Engine	Year	Length x Width>Note	MSRP
ABF-3	C230	2.3L L4 F/I	02	460X80	
		C180	00-02		
		C200			
OMB001	Smart City	0.6/0.7/0.8 L L3	97-03	Round	
		Smart Roadster	03-06		
		Smart Fortwo	04-07		
		Smart Fortwo	07-10		
		1.0L Turbo L3 F/I			
OMB002	C280	3.0L V6 DSL	05-09	249X210	
		C320			
		CLK320			
		CLS320	05-08		
		E280			
		E320	05-10		
		ML280			
		ML320			
		R320			
		S320			
		G320			
		GL320			
		C350	09-10		
		E350			
		G350			
		GL350			
		ML300			
		ML350			
		R280			
		R300			
R350					
S350					
OMB003	C180 KOMPRESSOR	1.8L L4 F/I	02-10	Round	
		C200 KOMPRESSOR			
		C230 KOMPRESSOR	02-05		
		CLK200 CGI	03-05		
		CLK200 KOMPRESSOR	02-08		
		C160	05-08		
		C200 CGI	03-08		
		C230	04-05		
		E200	04-06		
		E200 CGI	02-06		
OMB004	C200	2.1L L4 DSL	03-08	Round	
		C220			
		CLK220	05-09		
		C180	08-09		
		CLC160 KOMPRESSOR	09-10		
		CLC180 KOMPRESSOR			
CLC200 KOMPRESSOR					

**FOR MINI**

Item NO.	Car Make	Engine	Year	Length x Width>Note	MSRP
OMI001	Mini Cooper	1.6i 115hp auto trans	01-04	216x165	
		1.6/1.6i L4			
OH005	Mini Cooper s	1.6L L4 F/I (R53)	02-on	274X167	

**FOR MITSUBISHI**

Item NO.	Car Make	Engine	Year	Length x Width>Note	MSRP
OM001	Colt	1.3 L4 F/I	92-96	221X201	
		1.6/1.8	93-96		
		1.6/1.8 L4 F/I	92		
	Lancer	1.6L F/I	92-96		
		1.6/1.8 L4 F/I	92		
		2.0L L4 RS Turbo Evo			
Waja	1.5/1.8 L4 F/I	93-96			
	1.6	02-03			
OM002	Virage	1.8	97-08	215X203	
		Lancer	03-08		
	Lancer Evo VIII	1.3L L4 F/I	97-08		
		1.6 L4 F/I	04-on		
		2.4 L4 F/I - All	03-07		
	Mirage	2.0 L4 F/I	03-07		
2.0 L4 F/I		03-07			
Outlander	1.5/1.8 L4 F/I	97-04			
	2.0L L4 F/I	03-10			
OM003	GALANT	2.0	98-04	246X198	
		SAVRIN	01-10		
OM004	Freeca	2.0L L4	00-04	226X226	
		Space Gear			
OM005	ENDEAVOR	3.8 V6	04-10	233X219	
		ECLIPSE	05-10		
		GALANT	04-10		
		GRUNDER	05-10		
OM006	GRANDIS	2.0/2.4 L4 F/I	03-on	260X208	
OM007	TRITON	2.5/3.2 Dsl	05-on	240x240	
OM008	SPEC WAGON	2.4L L4 F/I	02-05	256x204	
		GALANT VI	96-04		
OT001	COLT PLUS	2.0L L4 F/I	99-04	250x122	
		2.5L L4 F/I			
		2.4L V6 F/I			
OM009	LANCER	1.6L L4 F/I	07-10	270x185	
		1.5L L4 F/I	08-09		
	FORTIS	1.8L L4 F/I	07-10		
		2.0L L4 F/I			
OUTLANDER	2.0L L4 F/I	08-10			
	2.0L L4 DSL	07-09			
	2.2L L4 DSL				
OB-002	ZINGER	3.0L V6 F/I	07-10	230x234	
		2.4L L4	06-10		

**FOR NISSAN**

Item NO.	Car Make	Engine	Year	Length x Width>Note	MSRP	
ON001	100	2.0 16v	91-95	280X168		
		2.0 D	90-95			
		1.8 SX Turbo	88-94			
		2.0 SX Turbo	89-94			
		200SX	1.6 L4 F/I			95-98
			1.8 turbo L4 F/I			89-94
		240SX	2.0 L4 F/I			94-97
			2.4 L4 F/I			89-98
		300	3.0 V6			87-90
		300ZX	3.0 V6 F/I			87-89
		350Z	3.5 V6 F/I			03-06
		810	2.4/2.8 L6			81

Item NO.	Car Make	Engine	Year	Length x Width>Note	MSRP	
ON001	Almera	1.5/1.8/2.0 16v	00-06	280X168		
		2.0 Dsl	96			
		2.0 D	95-00			
		2.0 Gti	97-00			
		2.0 L4 F/I	96-00			
		2.2 Di	00-06			
	Altima	2.4	93-01			
		2.4L L4 F/I	93-97			
		2.5/3.5	02-10			
	Axxess	2.4 L4 F/I	90-91			
	Bluebird	1.8i DOHC	1.8i			87-90
			1.8i Turbo			85-90
		2.0 D	80-84			
		2.0 D	87-90			
		2.0i	82-84			
		2.8 Dsl	83			
	Cedric	2.8 Dsl	83			
	Cefiro	2.0	2.0			03
			2.0 V6 24v			95-04
		2.0/3.0 QX	2.4			81-84
2.8			81-83			
3.0		86-01				
3.0 V6 24v		86-89				
3.0 V6 24v	90-04					
Cherry	1.7Dsl	86-on				
Frontier	3.3 V6 F/I	03-04				
Laurel	2.0 Dsl	80				
		86-on				
	2.4 L24	85				
	2.8 Dsl	87				
Maxima	3.0 F/I	86-89				
		2.0 V6	00			
	2.4L L6 F/I	81-84				
	2.8L L6 Dsl	81-83				
3.0 V6 F/I	81-83					
	86					
89-01						
3.5 V6 F/I	02-10					
Murano	3.5 V6 F/I	03-10				
NX	1.6/2.0 L4 F/I	91-93				
Pathfinder	3.3 V6 F/I	96-04				
		2.7L L6 DSL	97-04			
	2.4 L4 F/I	91				
3.0 V6 F/I	89-94					
Patrol (Safari)	2.0D	93-on				
	4.2	92-on				
Pickup	3.0 V6 F/I	89-91				
Prairie	2.0/2.4 L4 F/I	94-97				
		88-92				
Primera (Infiniti)	1.6L16v	02-06				
		90-08				
	1.8L L4 F/I					
	2.0 16v GT	90-96				
2.0 TD	96-06					
2.2 TD common rail	02-06					



**FOR NISSAN**

Item NO	Car Make	Engine	Year	Length x Width>Note	MSRP
ON001	Pulsar	1.6/1.8 L4 F/I	87-90	280X168	
	QX	3.0 V6 F/I	95		
	Sentra	1.5 L4 F/I	95		
		1.6 L4 F/I	91-97		
		1.8 L4 F/I	88,04		
		2.0 L4 F/I	91-93		
		2.5 L4 F/I	02-06		
	Serena	1.6i/2.0i	93-99		
		1.6/2.0 L4	93		
		2.0 16v	99-01		
		2.3 Dsl	95-01		
		2.5 Di	99-on		
	Silvia	1.8 F/I	83		
		1.8i	80-85		
		2.0 F/I	80		
	Skyline	2.0 6-cyl	92		
		2.5 24v V6 Turbo	93		
		GTR 24v V6 Twin Turbo	97		
	Stanza	2.4 L4 F/I	90-92		
	Sunny	1.5 turbo	86-87		
		1.5	85-87		
		1.6 16v	86-91		
		1.6, 1.8	90-98		
		1.7 Dsl	86-98		
		1.8 L4	88-91		
		2.0 16v GTi	91-on		
		2.0 L4 Dsl	92		
		2.0 L4 F/I	91-92		
		2.0 TD	99-on		
	Terrano	2.4 L4 F/I	93		
		2.4i L4 F/I	93-05		
		3.0 L4 F/I	92		
Tino	1.5 16v	00-06			
	1.8 16v				
	2.0 16v				
Vanette	1.6/2.0	91-on			
	3.3 V6 F/I	99-04			
Xterra	2.0 16v	01-06			
X-Trail	2.2 VDi	01-07			
	2.5L L4 F/I	03-07			
	TEANA	2.0/2.3/3.0/3.5	04-10		
QUEST	3.5 V6 F/I	04-10			
ON002	March	1.0 1.3 16V	92-on	170x157	
	Micra	1.0L L4 F/I	92-03		
		1.2L L4 F/I 16v	03		
		1.3L L4 F/I	93-20		
		1.3L L4 F/I 16v	92		
		1.4L L4 F/I	00-03		
		1.4L L4 F/I 16v	00-03		
Verita	1.3	93-97			
ON003	Almera	1.4/1.6	per-95	228x166	
	Almera	1.4L L4 F/I	95-96		
	Primera (Infiniti)	1.6L L4 F/I 16v DOHC	95-96		
	Sunny	SUNNY 1.4/1.6 L4 F/I	94		
	300ZX	3.0L V6 F/I	90-96		

Item NO	Car Make	Engine	Year	Length x Width>Note	MSRP
ON004	TIIDA/ LATIO	1.6/1.8L L4	04-10	230x135	
	Livian	1.6/1.8 L L4 F/I	07-10		
	VERSA	1.8L L4 F/I	07-10		
	MICRA	1.6L L4 F/I	05-09		
	NOTE	1.6L L4 F/I	07-09		
	QASHQAI	1.5L L4 DSL			
CUBE	1.8L L4 F/I	09-10			

**FOR OPEL**

Item NO.	Car Make	Engine	Year	Length x Width>Note	MSRP			
ON001	Corsa A	1.5 Dsl	88-93	280X168				
	Kadett	1.5 Dsl	89					
	Astra F	1.7 Dsl	91					
	Vectra A	1.7L L4 Dsl	92-95					
OO001	CORSA B	1.0L L3F/I 12V	97-00	213X167				
	CORSA B	1.2L L4 F/I	93-00					
	CORSA B	1.4L L4 F/I	93-00					
	CORSA B	1.5L L4 DSL	93-00					
	CORSA B	1.6L L4 F/I	93-00					
	CORSA B	1.7L L4 Dsl	94-00					
	COMBO A	1.2L L4 F/I	94-01					
	COMBO A	1.4L L4 F/I	94-01					
	COMBO A	1.7L L4 Dsl	94-01					
	TIGRA	1.4L L4 F/I	95-00					
OO002	ASTRA G	1.2L L4 F/I	98-99	292X233				
	ASTRA G	1.4L L4 F/I	98-03					
	ASTRA G	1.6L L4 F/I	98-04					
	ASTRA G	1.7L L4 Dsl	98-03					
	ASTRA G	1.8L L4 F/I	98-03					
	ASTRA G	2.0L L4 DSL	98-04					
	ASTRA G	2.0L L4 F/I	98-03					
	ZAFIRA	1.6L L4 F/I 16V	99-03					
	ZAFIRA	1.8L L4 F/I	99-04					
	ZAFIRA	2.0L L4 F/I	99-03					
OO004	VECTRA A	1.6L L4 F/I	88-95	288X185				
	VECTRA A	1.7L L4 Dsl	88-95					
	VECTRA A	1.8L L4 F/I	90-95					
	VECTRA A	2.0L L4 F/I	88-95					
	VECTRA A	2.5L V6 24V	93-95					
	ASCONA	1.7L L4 DSL	89-					
	CALIBRA	2.0L L4 F/I	90-98					
	CALIBRA	2.5L V6 24V	93-98					
	OO005	VECTRA B	1.6L L4 F/I			95-02	342x206	
		VECTRA B	1.8L L4 F/I			95-02		
VECTRA B		2.0L L4 F/I	95-00					
VECTRA B		2.5L V6 24V	95-00					
VECTRA B		2.6L V6 F/I	01-02					
SPEEDSTAR		2.2L L4 F/I	00-05					

**FOR OPEL**

Item NO.	Car Make	Engine	Year	Length x Width>Note	MSRP
OO003	Corsa/Corsa C	1.0 12v	00-06	290X205	
		1.2 16v			
		1.4 16v			
		1.7 16v Di			
		1.7 16v DTi			
	TIRGA	1.8 16v GSi			
		1.3L L4 DSL	04-10		
		1.4L L4 F/I			
		1.8L L4 F/I			
		MERIVA	1.3L L4 DSL		
1.4L L4 F/I					
1.6L L4 F/I					
1.7L L4 DSL					
1.8L L4 F/I					
COMBO	1.3L L4 DSL	03-09			
	1.4L L4 F/I				
	1.6L L4 F/I				
	1.7L L4 DSL				
	1.8L L4 F/I				
OO006	ASTRA G	2.2L L4 F/I	00-05	292X221	
	ZAFIRA		00-10		
	ASTRA H	1.9L L4 DSL	04-09		
	ZAFIRA		04-10		
	ASTRA H	1.6L L4 F/I TURBO	07-09		
	ZAFIRA	1.6L L4 F/I TURBO	09-10		
OO007	CORSA D	1.0L L3 F/I	06-10	203x211	
		1.2L L4 F/I			
		1.3L L4 DSL			
		1.4L L4 F/I			
		1.6L L4 F/I	07-10		
	COMBO	1.7L L4 DSL	06-10		
		1.3L L4 DSL	10		
		1.4L L4 F/I			
		1.6L L4 F/I			
		1.7L L4 DSL			

**FOR PERODUA**

Item NO.	Car Make	Engine	Year	Length x Width>Note	MSRP
OPE001	MYVI	1.0	05-on	310X170/Malaysia	
	AVANZA	1.0			
OPE002	MYVI	1.3	05-on	307X120/Malaysia	
OPE003	KELISA	1.0	02-on	Malaysia	
	KENARI	1.0	02-on		

**FOR PORSCHE**

Item NO.	Car Make	Engine	Year	Length x Width>Note	MSRP
OLD007	924	2.0L L4 F/I	77-79	211X211	
		2.0L L4 F/I (exc. Turbo)	80-82		
		2.0L W/K Jetronic	76		
		PORSCHE 912E 2.0L F6 F/I			
OPO001	914	4 L4	73-76	516X156	
	928	4.7L/5.0L/5.4L V8	78-95		
	928	4.5L/4.7L-S	78-86		

**FOR VAUXHALL(OPEL)**

Item NO.	Car Make	Engine	Year	Length x Width>Note	MSRP			
ON001	Astra/Belmont	1.7L Dsl	92	280X168				
	Nova Van	1.5L L4 Dsl	90					
	Nova	1.5L L4 Dsl	89-93					
	Cavalier	1.7L L4 Dsl	92					
OO001	CORSA B	1.0L L3F/I 12V	97-00	213x167				
	CORSA B	1.2L L4 F/I	93-00					
	CORSA B	1.4L L4 F/I	93-00					
	CORSA B	1.5L L4 DSL	93-00					
	CORSA B	1.6L L4 F/I	93-00					
	CORSA B	1.7L L4 Dsl	94-00					
	COMBO A	1.2L L4 F/I	94-01					
	COMBO A	1.4L L4 F/I	94-01					
	COMBO A	1.7L L4 Dsl	94-01					
	TIGRA	1.4L L4 F/I	95-00					
OO002	Astra F	1.4L L4 F/I 16V	98	292x233				
	Astra F	1.8L L4 F/I 16V	98					
	ASTRA G	1.2L L4 F/I	98					
	ASTRA G	1.4L L4 F/I	98-03					
	ASTRA G	1.6L L4 F/I	98-04					
	ASTRA G	1.7L L4 Dsl	98-03					
	ASTRA G	1.8L L4 F/I	98-03					
	ASTRA G	2.0L L4 DSL	98-04					
	ASTRA G	2.0L L4 F/I 16V	98-03					
	ASTRA MK4	1.4L L4 F/I	02-04					
OO004	CAVALIER MK3	1.6L L4 F/I	88-95	288x185				
	CAVALIER MK3	1.7L L4 DSL	88					
	CAVALIER MK3	1.8L L4 F/I	88-95					
	CAVALIER MK3	2.0L L4 F/I	88-95					
	CAVALIER MK3	2.5L V6 F/I	93-95					
	CALIBRA	2.0L L4 F/I	90-98					
	CALIBRA	2.5L V6 F/I	93-98					
	OO005	VECTRA B	1.6L L4 F/I			95-02	342x206	
		VECTRA B	1.8L L4 F/I			95-02		
		VECTRA B	2.0L L4 F/I			95-00		
VECTRA B		2.5L V6 24V	95-00					
VECTRA B		2.6L V6 F/I	01-02					
VX220		2.2L L4 F/I	00-05					



## FOR PEUGEOT

Item NO.	Car Make	Engine	Year	Length x Width/Note	MSRP
OC001	106	1.6L L4 F/I 16V GTI	97-03	310X115	
OFI002	307	1.6/2.0 16v	01-05	248X167	
		2.0 HDi 90/110hp	02-05		
	206RC	2.0 16V180BHP			
OP001	206	1.1 XR	98-06	207X170	
		1.4 XR/XT/XS	98-02		
		1.4L L4 F/I 8V	03-08		
		1.6 16v	01-04		
		1.6 XT/XS	98-99		
		1.6 XT/XS	99-04		
		2.0 16v	00-06		
		1.9L L4 DSL	98-01		
		2.0L L4 DSL	99-07		
OC002	1007	1.4L L4 F/I	05-09	333X100	
	1007	1.6L L4 F/I	05-09		
	PARTNER	1.4L L4 F/I	02-08		
	PARTNER	1.6L L4 F/I	02-07		
	207	1.4L L4 F/I -8V 85BHP	06-08		
	207	1.6L L4 F/I 109BHP	06-09		
OP002	307	1.6 16V L4 F/I	05-08	421x94	
	206	1.6 16V L4 F/I	05-08		
	PARTNER	1.6L L4 F/I	09		
OM009	4007	2.4L L4 F/I	07-09	270x185	
		2.4L L4 DSL			
OT010	107	1.0L L3 F/I	05-09	246X119	
OC004	206	1.4L L4 DSL 8V	00-09	281X140	
	307	1.4L L4 DSL 8V	03-07		
	107	1.4L L4 DSL 8V	05-08		
	1007	1.4L L4 DSL 8V	05-09		
	207	1.4L L4 DSL 8V	06-09		
	BIPPER	1.4L L4 DSL 8V	07		

## FOR PLYMOUTH

Item NO.	Car Make	Engine	Year	Length x Width/Note	MSRP
OM001	Colt	1.5/1.8 L4 F/I	93-94	221X201	
OV010	Acclaim	3.0	89-95	274X134	
	Horizon	2.2	88-90		
	Voyager	3.0	87-95		

## FOR PROTON

Item NO.	Car Make	Engine	Year	Length x Width/Note	MSRP	
OM001	Satria	1.8L L4 F/I	00-03	221X201		
		Persona	1.5/1.6			93
			1.8			96
		WIRA	1.6/1.8			94-on
		WAJA	1.6			02-on
OPR001	PERDANA	V6 2.0		229X186	Malaysia	
OPR002	GEN-2	1.6/1.3L L4	05-on	324X152	Malaysia	
OPR003	WIRA	1.3/1.5	94-on	220x198	Malaysia	
OPR004	SAGA II	1.3	08-on	322X139		
OPR005	SAVVY	1.3	07-on	365X82		

## FOR PONTIAC

Item NO.	Car Make	Engine	Year	Length x Width/Note	MSRP
OT004	VIBE	1.8L L4 F/I	02-08	289x148	
	Vibe GT				
OT013	VIBE	1.8L L4 F/I	09-10	240x175	

## FOR RELIANT

Item NO.	Car Make	Engine	Year	Length x Width/Note	MSRP
ON001	SS1	1.8 F/I	85	280X168	

## FOR RENAULT

Item NO.	Car Make	Engine	Year	Length x Width/Note	MSRP
OR001	Megane(Scenic)	1.4/1.6 16v	99-on	176X140	
		1.4/1.6 16v			
		1.8 16v	01-on		
		1.8 16v			
		2.0 16v	99-on		
		2.0 16v RX4	00-on		
		Clio III	1.4/1.6 16v		

## FOR ROVER

Item NO.	Car Make	Engine	Year	Length x Width/Note	MSRP	
OFO003	MGF	1.8	95-01	395x149		
OS001	820	16v	96	265x166		
		2.0 E//SE//SI//SLI/16v	92			
OH011	620	2.0L L4 SI//SLI//GSI 16V	93-99	245X136		
		623	2.3L L4F/I S/GDI//SLI			93-99
		618	1.8L L4 F/I ALL			96-00

## FOR SATURN

Item NO.	Car Make	Engine	Year	Length x Width/Note	MSRP
OO002	ASTRA	1.8L L4 F/I	08	292x233	

## FOR SAAB

Item NO.	Car Make	Engine	Year	Length x Width/Note	MSRP
OO004	900	2.5L V6 F/I	93-98	288x185	

## FOR SEAT

Item NO.	Car Make	Engine	Year	Length x Width/Note	MSRP				
OLD007	Terra	1.3/1.4 L4 DSL	90-95	211X211					
OV011	CORDOBA	1.9L L4 SDI-60BHP	99-02	355X183					
		IBIZA	1.9L L4 SDI-68BHP			99-02			
		LEON	1.6L L4 F/I-100BHP			99-02			
			1.8L L4 F/I			99-04			
			2.3L V5 F/I			99-02			
			1.9L L4 DSL			00-04			
			2.8L V6 F/I			01-04			
			TOLEDO			1.6L L4 F/I-100BHP	99-02		
						1.8L L4 F/I	99-04		
						2.3L V5 F/I	99-04		
						1.9L L4 DSL	99-04		
		OV013	TOLEDO			1.6/1.8/2.0L L4 F/I	91-98	273X183	
						1.9L L4 DSL	91-98		

## FOR SEAT

Item NO.	Car Make	Engine	Year	Length x Width/Note	MSRP	
OV013	IBIZA	1.8/2.0L L4 F/I	93-99	273X183		
		1.9L L4 DSL	93-99			
		CORDOBA	1.8/2.0L L4 F/I			93-95
			1.9L L4 DSL			93-99
			1.6/1.8/2.0L L4 F/I			96-99
			INCA			1.6L L4 F/I
		1.9L L4 DSL	95-01			
OV001	ALTEA	1.6L L4 DSL	09-10	341X135		
		1.8L L4 F/I	04-10			
		1.9L L4 DSL	04-09			
		2.0L L4 DSL	04-10			
		ALTEA XL	1.6L L4 DSL			09-10
			1.8L L4 F/I			06-10
		1.9L L4 DSL	06-09			
		2.0L L4 DSL	06-10			
		TOLEDO III	1.8L L4 F/I			07-09
			1.9/2.0L L4 DSL			04-09
		LEON	1.8L L4 F/I			08-10
			1.6L L4 DSL			09-10
		1.9L L4 DSL	05-09			
		2.0L L4 DSL	05-10			
OA001	EXEO	1.6L L4 F/I	09-10	263X210		
		1.8L L4 F/I				
		2.0L L4 F/I				
		2.0L L4 DSL				
OV-020	CORDOBA	1.4L L4 DSL	02-08	213X208		
		1.9L L4 DSL				
		2.0L L4 F/I	02-07			
		IBIZA IV	1.2L L3 F/I 6V			02-08
			1.4L L4 DSL			
		1.8L L4 F/I				
		1.9L L4 DSL				
		2.0L L4 F/I	03-06			
		IBIZA V	1.2L L3 F/I 6V			09-10
			1.4L L4 DSL			
		1.9L L4 DSL				
		2.0L L4 F/I	08			
OV-021	ALTEA	1.4L L4 F/I 85HP	06-10	375X191		
		ALTEA XL				
	CORDOBE	1.4L L4 F/I 85HP	06-08			
		1.6L L4 F/I 105HP				
	IBIZA IV	1.4L L4 F/I 85HP				
		1.6L L4 F/I 105HP				
	IBIZA V	1.4L L4 F/I 85HP	08-10			
		1.6L L4 F/I 105HP				
		LEON	1.4L L4 F/I 85HP			06-10
			1.4L L4 F/I			07-10
OV-022	ALTEA	1.6L L4 F/I	04-10			
		2.0L L4 F/I	04-07			
		ALTEA XL	1.4L L4 F/I			07-10
		1.6L L4 F/I	04-10			
		2.0L L4 F/I	04-07			
	TOLEDO III	1.4L L4 F/I	07-09			
		1.6L L4 F/I	04-09			
		2.0L L4 F/I(TURBO)	04-08			
	LEON	1.4L L4 F/I(125HP)	06-10			
		1.6L L4 F/I	05-10			
	2.0L L4 F/I(150HP)	05-07				

## FOR SCION

Item NO.	Car Make	Engine	Year	Length x Width/Note	MSRP
OT009	XA/XB	1.5 L4 F/I	03-07	246X119	
OT004	TC	2.4L L4 F/I	05-10	289x148	
OT013	XD	1.8L L4 F/I	08-09	240x175	

## FOR SKODA

Item NO.	Car Make	Engine	Year	Length x Width/Note	MSRP
OV013	FELICIA	1.9L L4 DSL	95-99	273X183	
		1.6L L4 F/I	96-97		
		1.3L L4 F/I	97-99		
OV004	SUPERB	1.8L L4 F/I TURBO	01-07	254X213	
		1.9L L4 DSL-TDI	01-04		
		2.0L L4 F/I	01-08		
		2.0L L4 DSL-TDI	05-07		
		2.5L V6 DSL-TDI	01-06		
		2.8L V6 F/I	01-06		
OV011	OCTAVIA	1.6L L4F/I	97-04	355x183	
		1.8L L4F/I	96-04		
		1.9L L4 SDI	97-04		
		1.9L L4 DSL	96-04		
		2.0L L4F/I	00-04		
OV001	OCTAVIA	1.8L L4 F/I	08-10	338X135	
		1.6L L4 DSL	09-10		
		1.9/2.0L L4 DSL	04-09		
	SUPERB	1.8L L4 F/I	08-10		
		1.9/2.0L L4 DSL	08-10		
	YETI	1.8L L4 F/I	09-10		
		2.0L L4 DSL			
OV020	FABIA	1.0L L4 F/I	99-02	213X208	
		1.2L L3 F/I 54BHP	01-09		
		1.4L L4 F/I-8V	99-05		
		1.4L L4 DSL	03-09		
		1.9L L4 DSL	99-09		
		2.0L L4 F/I	99-06		
	ROOMSTER	1.2L L4 F/I	07-09		
		1.4L L4 DSL	06-09		
		1.9L L4 DSL			
		PARKTIK	1.2L L4 F/I		
		1.4L L4 DSL			
OV021	FABIA	1.4L L4 F/I 80HP	06-09	375X191	
		1.6L L4 F/I			
	ROOMSTER	1.4L L4 F/I			
		1.6L L4 F/I			
	OCTAVIA	1.4L L4 F/I 80HP			
PRAKTIK	1.4L L4 F/I	07-10			
OV-022	SUPERB	1.4L L4 F/I	08-10	Round	
		OCTAVIA	1.4L L4 F/I		
		1.6L L4 F/I(102HP)	04-10		
		2.0L L4 F/I(150HP)	04-09		
	YETI	1.2L L4 F/I	09-10		





## FOR SSANGYONG

Item NO.	Car Make	Engine	Year	Length x Width>Note	MSRP
OSY001	MUSSO	3.2L V6	00-on	279X188	
OSY002	REXTON	2.7L 2.9L L5 3.2L V6	01-on 01-on	362X172	

## FOR SUZUKI

Item NO.	Car Make	Engine	Year	Length x Width>Note	MSRP
OFO001	LIANA	1.6 DOHC	04-06	244X157	
OS001	Solio	1.3 DOHC	01-08	265x166	
OS002	APV	1.5 sohc 16v	04-on		
OS003	VITARA	1.6L/2.0L L4	99-01	228X199	
	GRAND VITARA	2.5L/2.7L V6	99-05		
	GRAND VITARA	1.6L/2.0L L4	99-05		
	XL-7	2.7L V6	02-03		
OS004	SWIFT	1.5 L4	04-on	231x141	
	LIANA	1.6L L4	06-on		
OS006	SWIFT	1.3 L4	04-on	233x136	
OS007	GRAND VITARA	2.7L L4	06	230x176	
OS008	SWIFT	1.3L L4		320x156	
OS009	SX4	1.6L L4	07-09	230X130	
OBU001	RENO	2.0L L4 F/I	05-08	302X222	
	FORENZA	2.0L L4 F/I			

## FOR SUBARU

Item NO.	Car Make	Engine	Year	Length x Width>Note	MSRP
ON001	Forester	2.0 2.0 S Turbo 2.5 H4 F/I	99-05 02-08	280X168	
	Impreza	1.6 F/I 2.5 F4 F/I 2.0 F4 F/I(JP import)	93-00 05-07 93		
	Impreza GL/Sport/ Turbo	2.0 F4 F/I	94-00, 04		
	Impreza WRX	2.0 F4 F/I 2.0 F4 F/I(JP import)	94-05 93		
	Impreza I	1.6/1.8 16v 2.0i 16v Turbo 2.0i 4wd 115hp	93-on pre-00 95-on		
	Impreza II	2.0i 16v Turbo 4wd 217h/265p	01-05		
	Impreza WRX STI	2.5L H4 F/I	05-07		
	Legacy	2.0 16v 2.0 16v Turbo 2.0 Dsl 2.0 F/I 2.2 GX 2.2 F/I 3.0 F6 F/I	91-on 91-on 89-94 94 89-99 89 04-on		
	Outback	3.0 F6 F/I	00-03		
	Baja	2.5 F4 F/I	04-06		
	RS	1.8	88-89		
	RX	1.8	85-89		
	SVX	3.3	92-97		
OSU001	IMPENZA	2.0L/2.2L/2.5L	99-05	373X168	
	Legacy	2.5L H4 F/I 2.2L/2.5L H4 F/I	96-99 99-04		
	FORESTER	2.5L H4 F/I	99-04		
	OUTBACK	2.2L/2.5L H4 F/I	99-04		
	Baja	2.5L H4 F/I	03-on		
OSU002	LEGACY	2.5L H4 F/I	05-09	220X215	
	LEGACY	3.0L H6 F/I	08-09		
	LEGACY GT	2.5L H4 F/I	05-on		
	OUTBACK	3.0L H6 F/I	05-on		
	OUTBACK	2.5L H4 F/I	05-10		
	B9 TRIBECA	3.0L H6 F/I	06-07		
	TRIBECA	3.6L H6 F/I	08-10		
	IMPENZA	2.5L H4 F/I	08-10		
	IMPENZA WRX	2.5L H4 F/I	08-10		
	IMPENZA WRX STI	2.5L H4 F/I	08-10		

## FOR TOYOTA

Item NO.	Car Make	Engine	Year	Length x Width>Note	MSRP
ON003	Camry	1.8L L4 2bbl 1.8L L4 F/I 2.0L L4 F/I	82 88-91 82-91	228x166	
	Corolla	1.6L L4 F/I	83-88		
	Carina	1.8L L4 F/I ST150 2.0L L4 F/I ST171	85-88 87-88		
	Corona	1.8L F/I 2.0L DOHC	85 pre-87		
	Starlet	1.5L L4 Dsl	86		
	Celica	1.6L L4 F/I AT160	85		
OT001	Tercel	1.3/1.5	03-on	250x122	
OT002	Carina	1.6 1.6 16v 1.6/1.6SX 2.0 2.0 D 2.0 GLi	95-97 92-97 89-on 92-97 84-on 87-92	310X155	
	Celica	1.8 16v 2.0 16v/GT 2.0 GT/GTi	93-99 85-89 89-on		
	Corolla	1.6 GTi/Gli/Si 1.6 XLi 1.6/2.0 1.8 D 1.8 GTi 2.0 D	92-on 88-93 90-95 83-92 95-on 92-97		
	Exsior	1.6 /2.0	93-97		
	MR2	2.0	89-00		
	Picnic	2.0 16v	96-01		
	Premio	1.6/2.0	97-01		
	Rav-4	2.0 16v L4 Dsl	00-03		
	Yaris	1.3 1.5 TS	00-on 01-on		
	Yaris Verso	1.3 1.5 TS	00-on 01-on		
OT003	Corolla	1.6L L4F/I 1.8L L4 F/I 1.4L L4 F/I	93-02 93-01 97-02	267X169	
	CORONA	1.6L L4 F/I	93		

## FOR TOYOTA

Item NO.	Car Make	Engine	Year	Length x Width>Note	MSRP
OT004	Altis	1.6 1.8 L4 F/I 2.0 L4 F/I	01-07 01	289x148	
	Matrix	XR/XRS 1.8L L4 F/I	03-08		
	Corolla	1.6L / 1.8L L4 F/I 2.0 L4 F/I	02-07 01		
	Avensis	1.6/1.8/2.0/2.4L L4 F/I	03-08		
	T Sport	1.8L L4	02		
	wish	2.0L L4 16V	04-08		
	VERSO	1.6L L4 F/I 1.8L L4 F/I	07-09		
OT005	Pick-up	2.4 TURBO	84-88	269X172	
	Van	2.2	84-90		
	Corolla	1.6L L4 F/I 16v 1.6 L4 F/I 1.8L L4 F/I	92 93-97 93-01		
OT007	Camry	2.0/3.0 HYBRID 2.4L L4 F/I	97-01 07-10	318X193	
	Highlander	2.4L L4 F/I 2.7L L4 F/I 3.0L V6 F/I 3.3L V6 F/I 3.5L V6 F/I	01-07 08 01-03 04-07 08-09		
	Sienna	3.3 V6 F/I 3.5 V6 F/I	04-06 07-10		
	Solara	2.4 L4 F/I 3.3 V6 F/I	04-08		
OT009	Vios	1.5	03-10	246X119	
	Echo	1.5L L4 F/I	00-05		
	Yaris	1.5L L4 F/I	99-04		
OV008	Avalon	3.0L V6 F/I	97-01	309X185	
	Camry	2.2 2.2L L4 F/I 3.0 V6 F/I 3.0 V6 184hp 3.0 188hp 3.0 24v 190hp	91-01 97-01 97-01 00-01 91-96 96-06		
	Carina E	1.8 107hp	95-on		
	Celica	1.8L L4 F/I 2.0 GT Coupe 175hp	98-99 93-99		
	Sienna	3.0L V6 F/I	98-03		
	Solara	2.2L L4 F/I 2.4L L4 F/I 3.0L V6 F/I	99-01 02-03 99-03		
OT010	YARIS	1.0/1.3L L4	99-09	258X115	
	AYGO	1.0L L4	05-09		
OT011	LAND CRUISER	4.5L L6 4.2L L6 DSL	93-97 90-97	173X148mml	
OT013	YARIS	1.5L L4 VVT-i 1.8L L4 VVT-i	06-10 07-08	240x175	
	AURIS	1.4L L4 F/I 1.6L L4 F/I	07-09 07-09		
	COROLLA	1.4L L4 F/I 1.6L L4 F/I 1.8L L4 F/I	07-08 07-08 09-10		
	MATRIX	1.8L L4 F/I	09-10		
OT014	INNOVA	2.0L L4	05-10		
	VIGO	2.5L L4 DSL 3.0L L4 DSL	05-06 05-06		

Item NO.	Car Make	Engine	Year	Length x Width>Note	MSRP
OT015	CAMARY	2.0L/2.4 L4	06-10	292x200	
OT016	RAV4 III	2.2L L4 DSL	06-09	240X237	
	銳志	2.5	06-10		
OT017	CAMARY	3.5 V6 F/I	07-10	256X238	
	Avalon		05-10		
	MATRIX		09-10		
OHY006	PASEO	1.5L L4 F/I	91-99	235X123	
	TERCEL				
OD002	MR2 SPYDER	1.8L L4 F/I	00-05	251X157	
	CELICA GT	1.8L L4 F/I	00-05		
	CELICA GTS	1.8L L4 F/I	00-05		
	CELICA	2.2L L4 F/I 1.8L L4 F/I 1.6L L4 F/I	90-91 98-04 90-93		
	COROLLA	1.6L L4 F/I	88-89		
	TERCEL	1.5L L4 F/I TURBO	86		

## FOR VOLVO

Item NO.	Car Make	Engine	Year	Length x Width>Note	MSRP
OV001	164	3.0L	68-74	338X135	
	145/144/142	2.0L L4	69-73		
OVL001	850	2.0L F/I 20V TURBO 2.5L L5 F/I 2.4L L5 F/I 2.3L L5 F/I 2.5L L5 DSL TDI	92-97 92-97 92-97 92-98 96-97	346x181	
	C70	2.0L L5 F/I 2.3L L5 F/I TURBO T5 2.5L L5 F/I TURBO 2.5L L5 DSL TURBO 2.3L L5 F/I 2.4L L5 F/I	96-05 96-97 96-97 96-97 98-03 98-03		
	S70	2.0L L5 F/I 2.3L L5 F/I 2.5L L5 F/I TURBO 2.5L L5 DSL TURBO 2.4L L5 F/I	96-97 96-03 96-97 96-97 98-03		
	V70	2.0L L5 F/I 2.3L L5 F/I 2.5L L5 F/I TURBO 2.5L L5 DSL TURBO 2.4L L5 F/I	96-97 96-03 96-97 96-97 98-03		
	S60	2.0L L5 F/I	01-08		
	V70 II	2.0L L5 F/I	01-06		
OFO007	S40	1.6L L4 F/I 1.8L L4 F/I 2.0L L4 F/I	05-07 04-07 06-07	275X187	
	V50	1.6L L4 F/I 1.8L L4 F/I 2.0L L4 F/I	05-07 04-07 06-07		
	C30	1.6L L4 F/I 1.8L L4 F/I 2.0L L4 F/I	06-07		

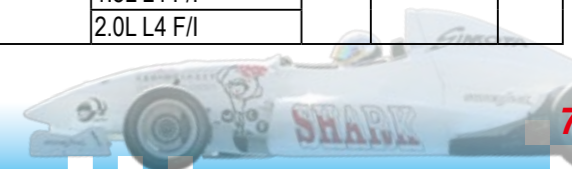



## FOR VOLVO

Item NO.	Car Make	Engine	Year	Length x Width>Note	MSRP	
OFO-010	V70 III	1.6L L4 F/I DSL	10	Round		
		V50	1.6L L4 F/I			07-10
			1.6L L4 F/I DSL			
			2.0L L4 F/I			
			2.0L L4 F/I DSL			
	S40II	1.6L L4 F/I				
		1.6L L4 F/I DSL				
		2.0L L4 F/I				
		2.0L L4 F/I DSL				
	C30	1.6L L4 F/I				
		1.6L L4 F/I DSL				
		2.0L L4 F/I				
		2.0L L4 F/I DSL				

## FOR VOLKSWAGEN

Item NO.	Car Make	Engine	Year	Length x Width>Note	MSRP	
OV001	Beetle (original)	1.2/1.3	72-75	338X135		
		BETTLE	1.6L L4			76-80
		TRANSPORTER	1.6L			70-71
		KARMANN	1.6L			72-74
		SCIROCCO	1.1L/1.5L			74-75
			1.6L L4			76
			1.4L L4 F/I 160BHP			08-10
			2.0L L4 F/I 211BHP			
			2.0L L4 DSL			
			RABBIT			1.5L L4
		1.6L L4	81-84			
		1.7L L4	82-83			
		SANTANA	1.5L L4			77-80
		1.6L L4	79-88			
		2.2L	85-88			
		1.8L L4	83-88			
		2.0L L5	83-88			
	DASHER	1.6L	81			
	VANAGON	1.6L L4	81-84			
	Quantum	1.6L L4	82-85			
		2.2L L5	83-87			
	CABRIO	1.8L L4	83-86			
	Caddy	1.6 D	82-92			
	GOLF	1.5	75-80			
		1.6 L L4	80-91			
		1.3L L4	87-90			
		1.6 D	83-91			
		GTI 1.8L L4	85-89			
		1.8L L4	84-89			
		GOLF II	1.9L L4 DSL(TDI)			05-09
			2.0L L4 DSL(TDI)			05-09
	GOLF VI	1.4L L4 F/I	05-09			
		140/170HP Turbo				
		1.4L L4 F/I 160HP	08-10			
	GOLF PLUS	2.0L L4 DSL(TDI)				
		2.0L L4 F/I 211HP				
		1.9L L4 DSL(TDI)	05-09			
		2.0L L4 DSL(TDI)	04-09			
		1.4L L4 F/I	05-09			
		140/170HP Turbo				
OV001		Jetta	1.5L	79-80	338X135	
	1.6 DL L4	80-92				
	1.3L L4	87-90				
	GTI 1.8L L4	86-91				
	2.0L L4 F/I	08-10				
	2.0L L4 DSL	09-10				
	Jetta V	1.4L L4 F/I	06-09			
	1.6L L4 DSL	09-10				
	1.9/2.0L L4 DSL	05-09				

## FOR VOLKSWAGEN

Item NO.	Car Make	Engine	Year	Length x Width>Note	MSRP
OV004	Passat	1.6L L4 F/I-	96-05	254X213	
		1.8L L4 F/I-3B MODEL	96-97		
		1.8L L4 F/I	98-05		
		1.9L L4 DSL-3B MODEL	96-05		
		2.3L V5 F/I	96-05		
		2.5L V6 DSL-TDI	96-05		
		2.8L V6 DSL-3B MODEL	96-05		
		2.8L V6 DSL	98-05		
		4.0L W8 F/I	01-04		



## FOR VOLKSWAGEN

Item NO.	Car Make	Engine	Year	Length x Width>Note	MSRP	
OV001	Passat I/II	1.5 D	77-80	338X135		
		1.6 D inc TD	79-88			
		1.8 with cat	83-88			
		2.0i 5-cyl	83-88			
		2.2L 5V	85-88			
		Passat	1.6L L4 DSL			09-10
			1.8L L4 F/I			07-09
			2.0L L4 F/I			09-10
		Passat CC	1.9/2.0L L4 DSL			05-09
			1.8L L4 F/I			08-09
			2.0L L4 F/I			08-10
		Touran	2.0L L4 DSL			08-09
			1.4L L4 F/I			06-10
		CODDY III	1.9/2.0 L4 Dsl			03-10
			1.9L L4 DSL			04-09
EOS	2.0L L4 F/I	09-10				
	2.0L L4 DSL	06-09				
TIGUAN	1.4L L4 F/I	07-10				
	2.0L L4 F/I					
	2.0L L4 DSL					
	GLI	2.0L L4 F/I	09-10			
OV002	Cabriolet	2.0	95-02	267X227		
		Golf III	1.4 8v multipoint			91-92
			1.6 101hp			95-97
			1.6 75hp			92-97
			1.8 8v			91-97
			1.9 D/TD			91-97
			1.9 TDi			93-97
			2.0 8v/Gti 8v			91-97
			2.0 GTI 16v			92-97
			2.8 VR6			91-97
			2.9 VR6			94-97
		Jetta	1.9			97
			1.9 95			94-95
		Vento	1.9 Diesel III			94
			2.0/2.8			93-97
1.8 CL/GL/GT	92-97					
1.9 D						
1.9 TD 75hp	91-97					
	1.9 TDi 110hp	96-on				
	1.9 TDi 90hp	93-97				
	OV005	Golf IV	1.4 16v	97-05	417X188	
	Lupo	1.4 16v	98-05			
	Polo IV	GTI 1.6 16v 125hp	01-05			
		1.4i 16v 100hp	99-02			
	Sharan	1.6 GTI 120hp	98-01			
		1.8 20v Turbo	01			
		1.9TDi 90/115hp				
		2.0 115hp				
		2.8 VR6				

## FOR VOLKSWAGEN

Item NO.	Car Make	Engine	Year	Length x Width>Note	MSRP			
OLD007	Polo I/II/III	1.3 Dsl	87-90	211X211				
		1.3 G40	90-94					
		1.3 GT/Fox	90-94					
		1.3 L4 DSL	87					
		1.3 L4 F/I	81-89					
		1.3 L4 F/I GT/G40	90-94					
		1.3i with panel filter	pre-94					
		1.4 Dsl	90-94					
		1.4 L4 DSL	90-97					
		Bus	1.7L L4 1 BBL			72-73		
			1.8L L4 F/I			74-75		
			2.0L L4 F/I			76-81		
			T2/T3 1.6L Petrol			pre-90		
			T2/T3 1.7/1.8 Petrol			pre-79		
		Camper	T2/T3 1.9L L4 Carb Petrol			82-90		
	T2/T3 1.9L L4 F/I Petrol							
	T2/T3 2.0L L4 Petrol		79-90					
	1.6/1.7 L4		72-75					
	1.8/2.0 L4 F/I		72-75					
	Transporter		1.7/1.8 L4	72-75				
1.9L L4 Carb Petrol			82-90					
1.9L L4 F/I Petrol								
2.0L L4 F/I			76-81					
2.0L L4 F/I			80-81					
Vanagon	2.0L L4 F/I Petrol	82-90						
	T2/T3 1.6 Petrol	pre-90						
	T2/T3 1.7/1.8 Petrol	pre-79						
	1.9L L4 F/I	80-86						
	2.0L F4 F/I	80-83						
OV008	Passat III	1.6i	88-95	309X185				
		1.8 16v	88-96					
		1.9 D	89-97					
		1.9 TD	pre-96					
		2.0 16v	88-96					
		2.0 8v 115hp	90-94					
		2.0 8v/16v	91-95					
		VR6	91-95					
		Corrado	GTI 16v (mechanical inj)			pre-90		
			GTI 8v (electronic inj)			88-91		
	Golf II	2.8i, 2.9 VR6	pre-96					
		1.6TD	89-91					
	Jetta	1.8 cat	87-91					
		OV009	EUROVAN			2.8L V6	90-94	278X219
	TRANSPRTER/T4		2.8L V6			95-01		
2.8L V6			95-03					
2.5L L5								
2.5L L5 TDI								
2.4L L5								
2.0L L4								
1.9L L4 TURBO								





## FOR VOLKSWAGEN

Item NO.	Car Make	Engine	Year	Length x Width>Note	MSRP	
OV010	SCIROCCO	1.6 GLi/GTi	pre-82	274X134		
		1.7	81-82			
		1.8 GTi inc 16v	82-92			
	Passat I /2(pre-88)	1.6 GLi	78-80			
		1.6	80			
	Jetta	1.7	81-84			
		1.6 GTi	83-on			
		1.8 GLi	82-83			
	Golf I	1.6 GTi	76-82			
		1.8 GTi	82-83			
	Commercial Caddy	1.8	85-92			
	Cabriolet	1.8	85-93			
	Dasher	1.6	76-81			
	Fox	1.8	87-90			
	GTI	1.7/1.8	84			
Quantum	1.7	82-83				
OV010	Rabbit	1.5	77-79	274X134		
		1.6	77-81			
		1.7/1.8	77-84			
OV011	Bora	1.6L L4 F/I FSi 110hp	98-05	355x183		
		1.8 20v Turbo 150hp	01-05			
		1.9 TDi 90/110/115hp	99-01			
		1.9 TDi 100/130/150hp	01-05			
		1.9TD	98-05			
		2.0 115hp				
		2.0i				
		2.3 V5 170hp				
		2.8 V6 24v 204hp	99-on			
		Golf IV	1.6 FSi 110hp			02-on
			1.6/1.8L L4 F/I			97-05
			GTI 1.8L L4 Turbo			
			1.9L L4 DSL			
			2.0i 116hp			98-on
			2.3 VR5			97-03
	Beetle (new)	2.8 V6 24v 204hp	99-03			
		3.2 V6 24v 240hp	02-04			
		1.9 TDi	00-09			
		2.3i V5 150hp	99-01			
		2.3i V5 170hp	01-05			
		1.6L L4 F/I	99-09			
	1.8L L4 F/I	99-07				
	1.9L L4 DSL	98-09				
	2.0L L4 F/I	98-09				
	2.5L L4 F/I	06-09				
	RSi 3.2 V6 225hp	00-01				

Item NO.	Car Make	Engine	Year	Length x Width>Note	MSRP
OV012	LUPO	1.0	98	310X235X55	
		1.4L L4	94-99		
	POLO	1.6L L4	94-95		
		1.0L L4	81-85		
		1.3L L4	81-95		
		1.3L CARB	83-91		
	GOLF	1.4L L4 CARB	91-97		
	VENTO	1.4L L4 CARB	91-97		
	JETTA	1.3L CARB	83-88		
	PASSAT	1.8L CARB	82-88		
	SANTANA	1.8L CARB	78-82		
	DERBY	1.1L CARB	78-82		
		1.3L CARB	78-83		
	OV013	POLO	1.6L L4 F/I -TYPR 6K		
1.9L L4 DSL			95-99		
1.8L L4 F/I			97-99		
	Caddy	1.7/1.9L L4 DSL	95-04		
OV014	SCIROCCO	1.5/1.6L L4 CARB	75-83	198X92	
		1.6/1.8L L4 CARB	75-92		
	GOLF /JETTA	1.6L L4 CARB	75-92		
		1.5L L4 CARB	77-84		
	CABRIO	1.8L L4 CARB	84-90		
		1.5L L4 CARB	79-83		
Caddy	1.6/1.8L L4 CARB	84-92			
	1.6L L4 CARB	82-92			
OO004	POLO	1.4L L4 DSL	01-on	288X185	
OV017	GOLF V	2.0 GTI L4	04-09		
		2.0L L4 F/I (200BHP)			
	JETTA V	2.0L L4 F/I (200BHP)	05-09		
		2.0L L4 F/I (200BHP)			
	PASSAT	2.0L L4 F/I (200BHP)			
		2.0L L4 F/I	06-08		
GOLF VI	2.0L L4 F/I (270BHP)	09-10			
OV020	POLO	1.2L L3 F/I 54BHP	02-10		
		1.4L L3 DSL	01-10		
		1.8L L4 F/I	05-09		
		1.9L L4 DSL TYPE 9N	01-10		
	Fox	2.0L L4 F/I	02-09		
		1.2L L3 F/I	05-09		
OV021	CADDY III	1.4L L4 F/I 80HP	06-09		
		1.6L L4 F/I 101HP			
	GOLF PLUS	1.4L L4 F/I 80HP			
		1.6L L4 F/I 101HP			
	GOLF VI	1.4L L4 F/I 80HP	09-10		

## FOR VOLKSWAGEN

Item NO.	Car Make	Engine	Year	Length x Width>Note	MSRP
OV022	CADDY III	1.6L L4 F/I	04-10	Round	
		2.0L L4 F/I			
		2.0L L4 F/I DSL	07-09		
		1.4L L4 F/I			
	EOS	2.0L L4 F/I (150HP)	06-09		
		1.4L L4 F/I(TSI)	07-09		
	GOLF V	1.6L L4 F/I (102HP)	03-09		
		2.0L L4 F/I (150HP)	04-09		
		2.0L L4 F/I DSL(75HP)	03-07		
		1.4L L4 F/I (122HP)	08-10		
	GOLF VI	1.6L L4 F/I (122HP)			
		1.4L L4 F/I (122HP)			
	SCIROCCO	1.4L L4 F/I (122HP)			
		1.6L L4 F/I (102HP)	03-09		
	TOURAN	2.0L L4 F/I (102HP)	03-08		
1.6L L4 F/I (102HP)		05-09			
JETTA V	2.0L L4 F/I (200HP)				
	1.6L L4 F/I (102HP)				
	2.0L L4 F/I (150HP)				
PASSAT	1.6L L4 F/I (102HP)				
	2.0L L4 F/I (150HP)				



## Welcome OEM and ODM Project !!

### Advantage:

- 1. Most durable air filter in the world**  
By one piece form mold technology, we ensure our products can bear the temperature range from -30°C ~ 150°C.
- 2. Increase at least 20% filtration space than other regular air filters.**  
Specialized in products skills, more deeper pleats to have more space to get air in.
- 3. Extra lightweight, cleanable and reusable.**  
Made of polyurethane construction, strong galvanized steel mesh coating simply demonstrated good appearance, and the weight is trimming down around 39% from the regular air filters.





# SIMOTA®

www.simota.com



**1** Take off the air filter inside stock intake box, which is either stabled by screw or buckled by tenon. If you have trouble removing it, please go to an authorized dealer close by for help.

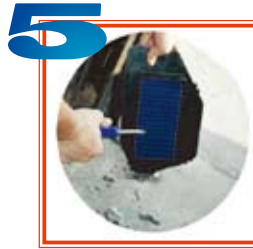

**5** Let it dry naturally or use the air gun to dry it.  
\*Do not use any other drying method could damage the filter\*



**2** Use the air gun briefly clean the dust and dirt attached on the surface of the filter.  
\*The unique material of SIMOTA's mesh can sustain the pressure released form all general air gun\*



**5** Apply by spraying a proper amount of SIMOTA Air Filter Oil evenly on the filter.  
\* Do not OVER-OIL-AIR FILTER. Over-oiling may interfere with the proper performance of the engine.\*



**3** After cleaning the surface, apply by spraying a proper amount of the SIMOTA Air Filter Cleaner evenly on the filter.  
\*the use of other cleaner for example detergent, bleach, and solution, could damage the filter.\*



**7** After waiting minutes for the oil to be absorbed into the filter mesh, install the filter back to the intake box. Be sure the crew is stabled or the tenon is buckled.



**4** Allow cleaner to soak into the filter mesh, and than use the air gun to clean it. Repeat Step 3 and Step 4 until all traces of cleaner are gone.

## Performance / Feature

Service the filter at least every 5,000 kilometers to maintain optimum performance.

We commend that the filter be serviced more often on off-road and high-performance street applications. Always inspect your filter whenever you change your oil.



OC-01

OC-02

**USE ONLY SIMOTA AIR FILTER CLEANER AND OIL KIT.**

**USE FO OTHER BRADS ARE NOT COMMENDED AND MAY VOID YOUR WARRANTY.**



WWW.SIMOTA.COM